

varian 

chromatography systems

2700 mitchell drive/walnut creek/ca 94598-1675/u.s.a.



PC-CONTROLLED 8200/SPME

OPERATOR'S MANUAL

Table of Contents

SECTION 1

INTRODUCTION	5
8200 CX AUTOSAMPLER FEATURES	5
INJECTION METHODS	6
LIQUID INJECTION.....	6
SPME INJECTION	6
AMBIENT HEADSPACE INJECTION	6
SYSTEM DESCRIPTION	6
STORAGE MODULE.....	7
PNEUMATICS MODULE.....	9
INJECTION TOWER MODULE	11
CX AUTOSAMPLER SPECIFICATIONS	15
PERFORMANCE	15
PHYSICAL	15
ENVIRONMENTAL.....	16

SECTION 2

INSTALLATION	17
UNPACK AND INSPECT THE 8200 CX AUTOSAMPLER	18
UNPACK THE 8200 CX AUTOSAMPLER	18
INSPECT THE 8200 CX AUTOSAMPLER.....	18
REMOVE THE CARRIAGE TIE DOWN	19
GC TOP COVERS AND THE 8200 CX AUTOSAMPLER	20
INSTALL THE MOUNTING HARDWARE ON THE GC TOP COVER	20
VARIAN GAS CHROMATOGRAPHS.....	20
INSTALL THE MOUNTING PLATES.....	21
CONNECTING THE 8200 CX CABLES	21
CONNECTING THE SERIAL CABLE TO A PC OR VARIAN WORKSTATION.....	22
CONNECTING THE STATUS CABLE TO A VARIAN GC (PC CONTROL ONLY)	24
INSTALLING SPME II HARDWARE	27
INSTALL THE STATIC GROUND STRAP.....	28
REPLACE THE OLD ROM.....	28
INSTALL THE ADJUSTABLE VIAL RETAINER	29
MOUNT THE 8200 CX AUTOSAMPLER	30
CONNECT POWER TO THE 8200 CX AUTOSAMPLER	32
VIAL RETAINER ALIGNMENT	34
INSTALLING SOFTWARE	34
ON A PC OTHER THAN A STAR CHROMATOGRAPHY WORKSTATION (INCLUDING A SATURN PC).....	34
ON A STAR CHROMATOGRAPHY WORKSTATION	35
HOW TO CONFIGURE THE AUTOSAMPLER	36
SPECIFY THE 8200 HARDWARE CONFIGURATION	39

FINAL INSTALLATION CHECK.....43
 INSTALLATION ON HP 5890 GAS CHROMATOGRAPHS44
 INSTALL THE VARIAN TOP COVERS.....47
 CONNECTING THE STATUS CABLE TO A HP 5890 GC49

SECTION 3

LIQUID INJECTION SETUP53
 CONNECT THE PNEUMATICS.....53
 INSTALL THE SOLVENT RESERVOIR BRACKET54
 ROUTE THE SOLVENT AND WASTE LINES.....55
 INSTALL THE SYRINGE/NEEDLE ASSEMBLY56
 ALIGN THE SYRINGE NEEDLE WITH THE INJECTOR PORT58
 BUILD THE LIQUID INJECTION METHOD.....60
 BUILD A NEW LIQUID INJECTION METHOD60
 SPECIFY THE CONFIGURATION WINDOW OPTIONS62
 SAVE YOUR METHOD.....69
 FINAL LIQUID INJECTION METHOD CHECKLIST69

SECTION 4

LIQUID INJECTION OPERATION.....71
 SAMPLING71
 LOADING THE CARROUSEL71
 SOLVENTS AND SOLVENT RESERVOIRS71
 SAMPLE VIALS.....74

SECTION 5

SPME INJECTION SETUP77
 BUILD A NEW SPME INJECTION METHOD77
 SPECIFY THE CONFIGURATION WINDOW OPTIONS79
 SAVE YOUR METHOD.....80
 INSTALL THE FIBER HOLDER ON THE SYRINGE CARRIAGE.....80
 ALIGN THE FIBER WITH THE INJECTOR PORT82
 ADJUST THE VIAL RETAINER ARM HEIGHT84
 FINAL SPME INJECTION METHOD SETUP CHECKLIST.....85

SECTION 6

SPME INJECTION OPERATION.....87
 SAMPLING87
 LOADING THE CARROUSEL87
 SAMPLE VIALS.....87
 CONDITIONING THE FIBER89
 SAMPLE VOLUMES89
 SETTING THE SPME/GC PARAMETERS89
 RUNNING THE TEST SAMPLE89

SECTION 7	
SPME III WITH AGITATION	93
INTRODUCTION.....	93
OPERATION OF THE SPME AGITATION ACCESSORY	94
PRINCIPLES OF OPERATION.....	94
DESCRIPTION OF THE AGITATION DEVICE	94
INSTALLATION.....	95
SETUP AND OPERATION	96
INSTALLATION OF AGITATOR SEPTUM.....	97
INSTALLATION OF SPME FIBER HOLDER.....	97
BUILDING A METHOD THAT INCLUDES AGITATION.....	98
CHANGING FROM SPME III TO LIQUID SAMPLING.....	98
TROUBLESHOOTING AND MAINTENANCE.....	101
METHOD DEVELOPMENT HINTS	101
SECTION 8	
AMBIENT HEADSPACE INJECTION SETUP	103
BUILD THE AMBIENT HEADSPACE INJECTION METHOD	103
SPECIFY THE CONFIGURATION WINDOW OPTIONS.....	105
SAVE YOUR METHOD	107
CONNECT THE PNEUMATICS	108
REMOVE SOLVENT FROM THE SOLVENT LINES	109
FLUSH THE SOLVENT LINES	109
INSTALL THE 100- μ L SYRINGE ASSEMBLY.....	110
ALIGN THE SYRINGE NEEDLE WITH THE INJECTOR PORT.....	111
FINAL AMBIENT HEADSPACE SETUP CHECKLIST	112
SECTION 9	
AMBIENT HEADSPACE INJECTION OPERATION	113
SAMPLING	113
LOADING THE CARROUSEL.....	113
100- μ L SYRINGE HEADSPACE INJECTION METHOD.....	113
SECTION 10	
AUTOMATED LARGE VOLUME INJECTION SETUP AND OPERATION	115
INTRODUCTION.....	115
COMPONENTS NECESSARY FOR LVI	115
UPGRADING GC CONTROLLED 8200 CX AUTOSAMPLER TO PC CONTROLLED 8200 CX AUTOSAMPLER	116
SECTION 11	
PERFORMING INJECTIONS	125
INJECTING A SINGLE SAMPLE.....	125
ACTIVATE A METHOD.....	125
INJECT THE SAMPLE	128

CREATING AND RUNNING A SAMPLELIST.....	130
BUILD THE SAMPLELIST	130
FILL IN THE SAMPLELIST	131
HOW TO SET THE DEFAULT SETTINGS.....	133
HOW TO DELETE SAMPLELIST ENTRIES.....	134
DOWNLOADING A METHOD FROM THE SAMPLE LIST	134
BEGIN THE SAMPLELIST.....	136
BUILDING AND RUNNING A SEQUENCE	137
OPEN THE ACTIVE SEQUENCE WINDOW	137
HOW TO ADD A LINE	138
SET THE ACTION, METHOD AND SAMPLELIST/LOG	139
BEGIN YOUR SEQUENCE	139
AUTOMIX.....	140
SECTION 12	
APPLICATION NOTES.....	143
SECTION 13	
MAINTENANCE/TROUBLESHOOTING	151
SYRINGE CARRIAGE GUIDE RODS	152
SYRINGE CARRIAGE DRIVE BELT.....	152
SOLVENT COMPATIBILITY	153
SYRINGE AND SYRINGE NEEDLE MAINTENANCE	154
SYRINGE CARE.....	154
NEEDLE CARE AND REPLACEMENT	154
REPLACING THE MAIN POWER FUSE	155
INSTRUMENT TROUBLESHOOTING.....	155
SECTION 14	
8200 CX AUTOSAMPLER WITH THE SATURN GC/MS	163
INSTALLATION.....	163
OPERATION.....	163
OPERATION NOTES.....	165
SECTION 15	
8200 CX PARTS AND SUPPLIES	167
SPME FIBERS (3 FIBERS PER PACKAGE)	168
INDEX	169

Section 1

Introduction

The Varian 8200 CX AutoSampler is a low loss, low volume autosampler. It mounts on all Varian 3000 Series Gas Chromatographs, and on other selected gas chromatographs such as the HP 5890 GC.

You can install the AutoSampler yourself.

8200 CX AUTOSAMPLER FEATURES

The 8200 CX AutoSampler.

- Supports multiple sampling injection methods, including Liquid, Solid Phase MicroExtraction (SPME), and Ambient Headspace Injection.
- Accepts 10 µL or 100 µL syringe.
- Uses a solvent flush sample injection technique (Standard Liquid Injection).
- Injects neat, viscous, and volatile samples (Liquid Injection).
- Accommodates 100, 120, 220, and 240V power.
- Is compatible with Varian 1040, 1041, 1060, 1061, 1075,¹ 1077, 1078, and 1093/1094² injectors.
- Is compatible with the Hewlett Packard split/splitless injector.
- May be controlled from the Varian Star Chromatography Workstation or other PC running Windows.
- Permits syringe washing with up to two solvents (Liquid Injection).
- Allows you to program the syringe needle depth in the vial (Liquid or Ambient Headspace or SPME Injection).
- Can be used with a 48-vial (2 mL) or 12-vial (10 mL) carousel.
- Consists of a pneumatics module, injection tower, and storage module in a single compact unit.
- Permits easy access to the pneumatics.
- Supports agitation of the sample during SPME.

¹ Front position Star 3400 CX only

² Septum-Equipped Programmable Injector (SPI)

INJECTION METHODS

You may perform liquid, Solid Phase MicroExtraction (SPME), or ambient headspace injections with the 8200 CX AutoSampler.

LIQUID INJECTION

Four liquid injection modes (Standard Solvent Flush, Volatile, Neat, and Viscous) are pre-programmed with optimized parameters for specific samples. A fifth mode, the user-defined mode, allows you to optimize parameters for specific samples. The sandwich, or solvent-flush, injection technique reduces mass discrimination and provides optimum accuracy and precision; it is built into the viscous and volatile injection modes.

SPME INJECTION

Solid Phase MicroExtraction (SPME) is an extraction technique for organic compounds in aqueous samples in which analytes are absorbed directly from the sample or the sample headspace onto a fused silica fiber that is coated with an appropriate stationary phase. While the fiber is inserted in the sample or its headspace, the analytes partition from the sample matrix into the stationary phase until equilibrium is reached. The fiber is then inserted into a capillary injector port of the gas chromatograph where it is heated, and the analytes are rapidly thermally desorbed into the capillary GC column for analysis. SPME can be used with 1075, 1077, 1078, 1093 and 1094.

AMBIENT HEADSPACE INJECTION

Ambient headspace analysis can be used to determine organic solvents in aqueous matrices (e.g., ethanol in blood or urine, solvents in waste water). Generally, volatiles in a solid matrix are not detected in the headspace of an unheated system. A 100- μ L syringe is used with the 8200 CX AutoSampler for ambient headspace analysis.

SYSTEM DESCRIPTION

The 8200 CX AutoSampler mounts over the injectors on the top cover of the Varian Series 3000 Gas Chromatographs, and on special top covers for other selected gas chromatographs. Existing covers may also be modified on certain gas chromatographs.

A power entry module located on the rear panel of the pneumatics module supplies power to the AutoSampler. The rear panel also contains the main power switch, fuse(s) and voltage selection components.

You can operate the AutoSampler at 100, 120, 220, and 240 Volts, 50/60 Hz, with single phase, or split phase (phase/phase) power. For information about selecting the appropriate voltage for the AutoSampler, see **Connect Power to the 8200 CX AutoSampler** on Page 32. For information about changing fuses, see **Replacing the Main Power Fuse** on Page 155.

The AutoSampler has three modules: the storage module, pneumatics module, and injection tower module, as shown in the following diagram.

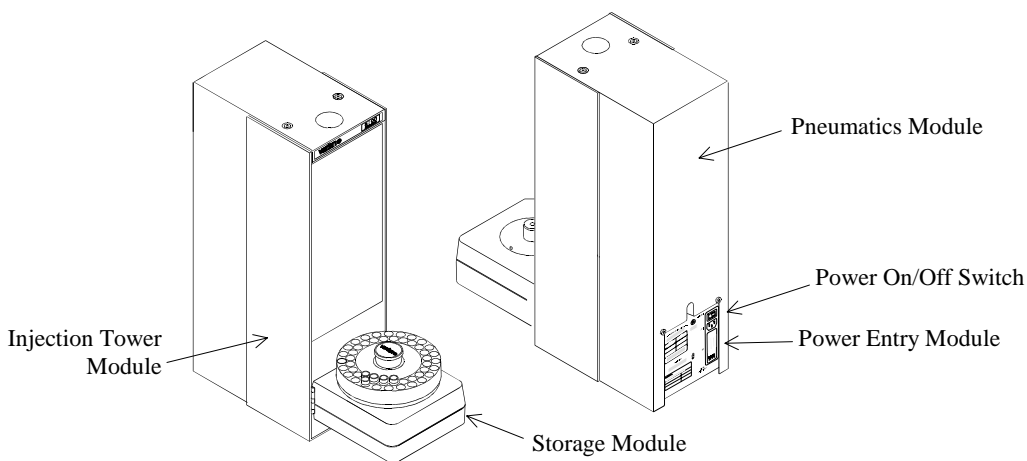

STORAGE MODULE

The storage module consists of a 48- or 12-vial carousel, turntable, position sensor board, vial sensors, and two synchronous motors that rotate the turntable and move it in and out of the sampling position. The storage module is hinged to the injection tower with left-hand (standard), or right-hand (optional for the Star 3600 CX GC) mounts.

The power ON indicator (LED) is located on the front right side of the storage module. This LED lights up when the power cord is properly connected and the AutoSampler power switch is ON. The power switch is located on the rear of the tower.

Carrouseles

- 48-vial Carrousel

The 48-vial carrousel is constructed of a chemically resistant polymer. It is 5-3/4 inches in diameter by 1-1/4 inch deep, and can hold up to forty-eight 2-mL vials. A center knob allows you to lift and reposition the turntable. A small raised indicator marks the Home vial position. See the following diagram.

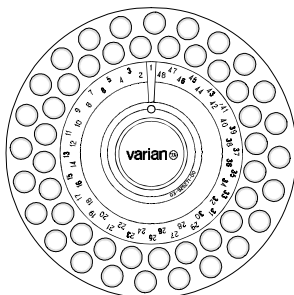

The carrousel label designates the location of the 48 vials, as well as the location of the Home position (Vial 1). You position the label on the carrousel using the keyed cutout. See the following diagram. The carrousel label is affixed with a semi-permanent adhesive that permits the label to be easily removed and replaced. Section 15, **8200 CX Parts and Supplies**, provides ordering information for additional labels.

NOTE: The 48-vial tray can be placed on the turntable in any position.

- 12-vial Carrousel

The 12-vial carrousel is constructed of anodized aluminum. It is 5-3/4 inches diameter by 1-1/4 inches deep, and can hold up to twelve 10-mL vials. A center knob allows you to lift and reposition the turntable. A small raised indicator marks the Home vial position. See the following diagram.

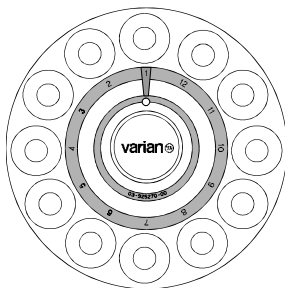

The carousel label designates the location of the 12 vials, as well as the location of the Home position (Vial 1). You position the label on the carousel using the keyed cutout. See the diagram below. The carousel label is affixed with a semi-permanent adhesive that permits the label to be easily removed and replaced. Section 15, **8200 CX Parts and Supplies**, provides ordering information for additional labels.

NOTE: The 12-vial tray must be placed on the turntable with the pin aligned with vial 1.

Turntable

Two synchronous motors drive the turntable: One motor rotates the turntable clockwise, and the other moves it backward or forward. The carousel mounts on the turntable and rests on a vertical pin on the outer edge of the turntable. See diagram below.

NOTE: Make sure the carousel is firmly seated whenever you place it on the turntable.

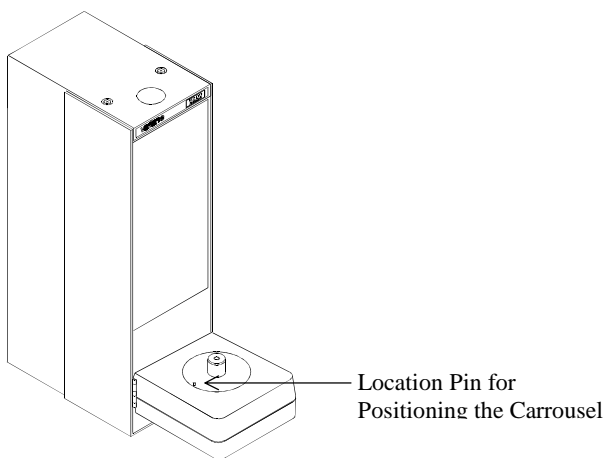

PNEUMATICS MODULE

The pneumatics module houses the solvent and air solenoid valves that control solvent and air to the solvent reservoirs and regulator; the power transformer; the main power switch, fuses, and voltage selection module; and the Controller PC Board. Gas (at 40 to 60 psig) enters the pressure regulator. The pressure regulator is preset to 20 psi (outlet) at the factory. You should not have to further adjust the gas pressure. Gas is distributed to four valves (L1, L2, L3, L5) that control pressure and solvent flow from reservoirs A and B. The solenoid valves in the pneumatics module connect to J8 on the 8200 CX Controller PC Board.

- A Pressurization Valves
- B Solvent Distribution Valves
- C To Syringe Side Arm
- D Power Entry Module
- E Transformer
- F Gas/Air Input, 40-60 psig
- G Pressure Regulator

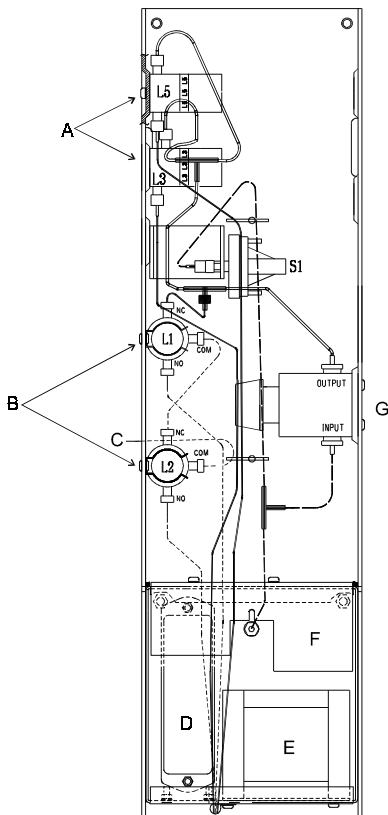

Solenoid Valves Assignments

The solenoid valves in the pneumatics module are assigned as follows:

- L1 controls solvent flow from Reservoir B to the syringe side arm.
- L2 controls solvent flow from Reservoir A to the syringe side arm.
- L3 pressurizes solvent Reservoir A.
- L5 pressurizes solvent Reservoir B.

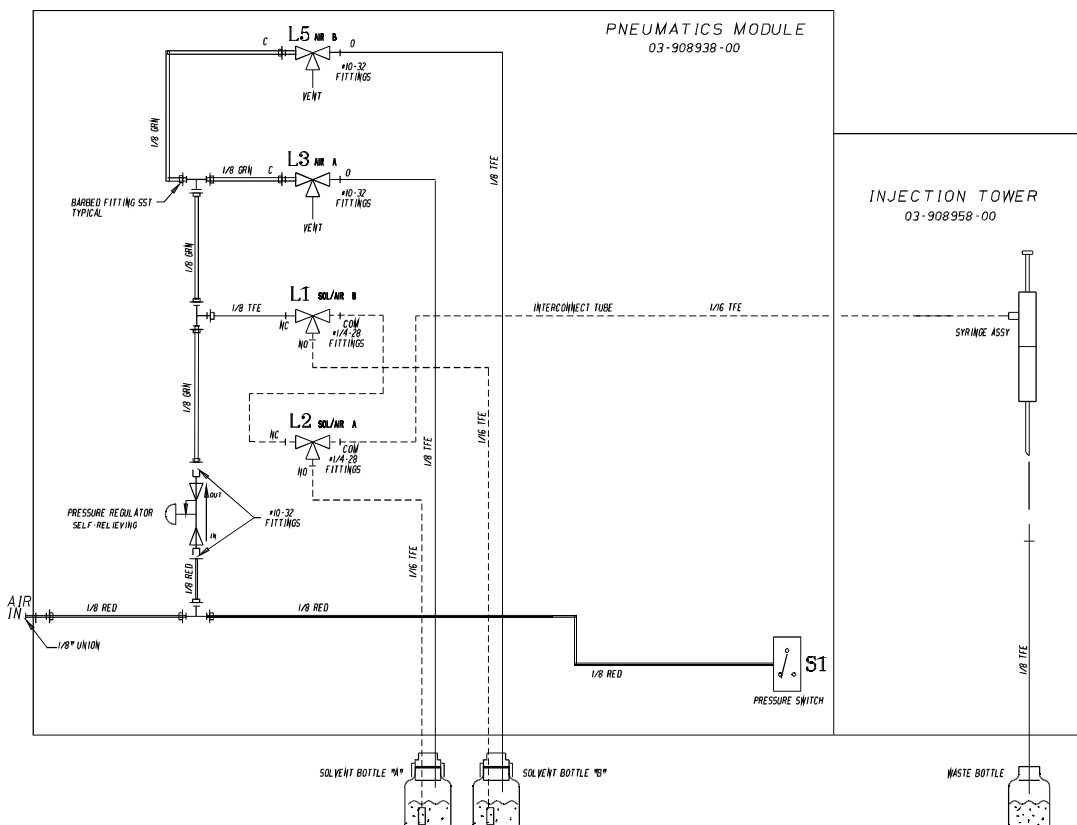

Power Entry Module

The power entry module sits on the lower rear panel of the pneumatics module. It includes a main power switch; main power cord receptacle; fuse(s); and voltage selection card. Before powering up the 8200 CX AutoSampler, make sure that the white voltage pin is in the hole that matches the voltage rating on the serial number label, as described on Page 32, **Connect Power to the 8200 CX AutoSampler**. If you need to change a fuse, see Page 155, **Replacing the Main Power Fuse**.

INJECTION TOWER MODULE

The injection tower module houses the syringe carriage and syringe mounting hardware, the syringe carriage drive stepper motor, the waste cup, and the syringe plunger stepping motor drive assembly. The hinged storage module and pneumatics module both bolt to the injector tower module.

The stepping motor and drive belt move the syringe carriage through the vial sampling, injecting, and washing positions. See the following diagram.

- A Syringe Plunger Lead Screw
- B Belt Tensioner/Pulley
- C Syringe Carriage Stop Latch Solenoid
- D To Position #4 on J8
- E Syringe Carriage Drive Belt
- F To Position #7 on J8
- G Syringe Carriage Drive Motor
- H Syringe Carriage

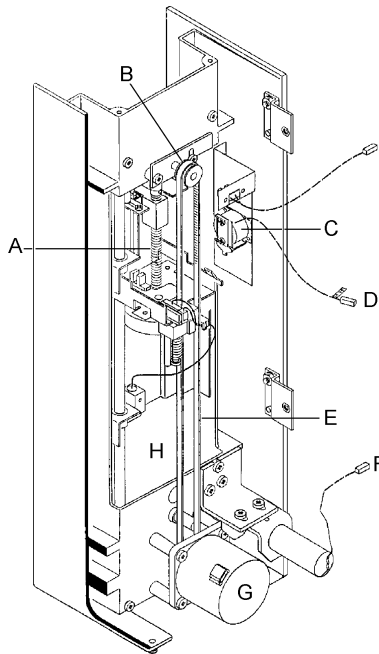

At the end of a run, the syringe carriage returns to the Home position. If power is turned off or if there is a power failure, the stop solenoid opens and the carriage drops to its rest position on the stop latch. When power is restored, the stop solenoid pulls in and the carriage returns to its operating Home position.

Liquid Injection

The liquid injection syringe/needle assembly (P/N 03-918986-00) includes the following:

- 10- μ L syringe with a side inlet fitting
- plunger guide
- non-coring side hole needle (P/N 03-918987-00)

The 10 μL syringe is shown schematically in the following diagram.

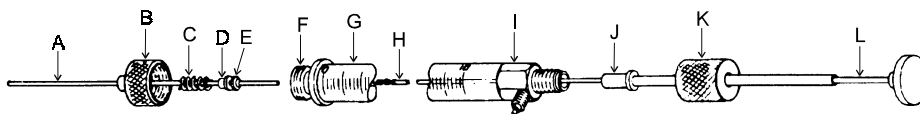

- A Needle
- B Syringe Nut
- C Spring
- D Needle Stop
- E PTFE Needle Seal
- F Front Screw Thread
- G Syringe Barrel
- H PTFE Plunger Tip
- I Side Arm Tee
- J Plunger Guide and Thrust Assembly
- K Lock Nut
- L Plunger

SPME Injection

The SPME holder with fiber assembly is shown below.

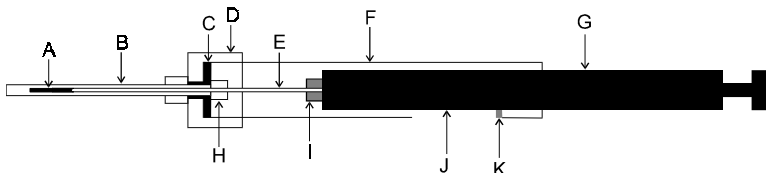

- A SPME Fiber
- B Septum Piercing Needle
- C Needle Ferrule
- D Retaining Nut
- E Fiber Attachment Needle
- F Barrel
- G Plunger
- H Sealing Septum
- I Color-Coded Screw Hub
- J Slot
- K Retaining Screw

Waste Arm/Cup Assembly

The waste arm, which is used with the Liquid and Ambient Headspace injection methods, is electrically driven to the “out” position by an electrical solenoid; a spring returns it to the “in” position. The waste arm positions the cup under the needle during washing or flushing cycles. The cup remains in the retracted position during sample injection.

When it becomes necessary to change the waste cup septum, replace it only with a Varian septum (P/N 00-997628-00). The Standard Accessory Kit (03-908989-90) includes a supply of these septa. You install the new septum with the Teflon®-coated surface down, as seen in the diagram below.

There is no fixed schedule for changing the waste cup seal. You should, however, change it if you see signs of leakage or sample carryover.

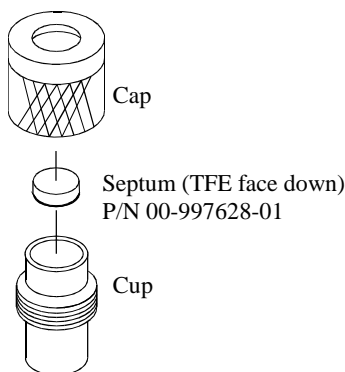

Vial Retainer Arm

The vial retainer arm is a metal bar clamped in a plastic holder. It is positioned just above the hole in the sample vial cap. The retainer prevents the vial from being lifted out of the carousel when the needle is withdrawn. During injection, as the syringe carriage descends, it moves the retainer out of the syringe carriage path. When the syringe carriage moves up from the inject position, the retainer returns to its normal position over the vial. The following diagram shows the retainer in its correct position.

The vial retainer arm is adjusted at the factory to align with the syringe needle guide. If the vial retainer arm is out of position, the arm could either interfere with the operation of the needle guide, or fail to hold the vial in the carousel during the withdrawal of the syringe needle. Turn the adjusting screw to position the retaining arm as shown.

**CAUTION**

Adjust Height of Vial Retainer Arm When Changing Vial Size.

- A Vial Retainer Arm Block
- B Vial Retainer Arm
- C Syringe Needle Guide Arm
- D Adjusting Screw

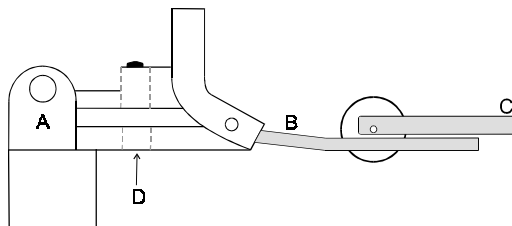

CX AUTOSAMPLER SPECIFICATIONS

PERFORMANCE

Peak Area: <1.0% RSD typical in standard mode (Liquid Injection) for all injector types except split/splitless injectors (1075/1077/1078) where typical RSD is <1.5%.

Carryover: <0.05% typical with default values.
<0.01% when wash cycle is lengthened by increased viscosity factor or with multiple solvent wash.

PHYSICAL

Height: 19.5 inches (49.5 cm)

Width: 6.0 inches (15.5 cm)

Depth (Including Storage Module): 15.75 inches (40 cm)

Weight: 24 lb (10.9 kg)

Sample Capacity: 48 samples contained in 2-mL screw-cap or crimp-top vials, standard microvials with internally machined conical volume or microvial inserts. These types can be mixed within the sample carousel. Wash vials are not required. Alternately, 12 samples contained in 10-mL sample-volume crimp-top vials.

Liquid Injection Syringe:	Flow-through design to allow dynamic washing; standard 10- μ L syringe with Teflon®-tipped plunger. Options include 100- μ L syringe and SPME fiber holder.
Sampling Methods:	Liquid Injection (Standard, Volatile, Neat, Viscous, and User Defined modes); SPME Injection; and Ambient Headspace Injection.
Programmable Uptake Speed	1.0 to 5 μ L/sec
Programmable Injection Speed:	0.2 to 10 μ L/sec
Programmable Residence Time:	0 to 10 minutes
Programmable Hot Needle Time:	0 to 1.0 minute
Sample Size:	Programmable from 0.1 to 10.0 μ L with 10- μ L syringe. Programmable from 1 μ L to 100.0 μ L with 100- μ L syringe.
Sample Waste:	Less than 0.1 μ L per injection in standard solvent-flush mode (Liquid Injection).
Minimal Sample Volume (Liquid Sampling):	2-mL vials: 300 μ L Microvials: 10 μ L 10-mL vials: 5 mL
External Wash Solvent:	Choice of solvent A and/or solvent B for Liquid Injection.
Sample Coding:	Vials 1-48, or vials 1-12.

ENVIRONMENTAL

For optimum 8200 CX AutoSampler performance, check that the operating environment meets the following specifications:

Temperature:	Operating: 10 to 40°C Storage: -20 to 65°C
Humidity:	Operating: to 80% non-condensing
Power:	90 to 264 Vac operating range with four selectable voltages: 100, 120, 220, 240 Vac (\pm 10%) Frequency: 50/60 Hz Power Consumption (Maximum): 55 VA

Section 2

Installation

To install the 8200 CX AutoSampler prior to setting up an injection method, you will

- Unpack and inspect the 8200 CX AutoSampler.
- Install a new GC top cover (selected GCs only).
- Install the mounting hardware on the GC top cover.
- Install the serial and status cables.
- Install the SPME hardware (SPME Injection only).
- Mount and secure the AutoSampler to the mounting plates.
- Check that the operating voltage label and voltage selection pin agree with the on-site power rating, that a properly rated fuse has been installed, and that the power cord has been connected.
- Install and configure the AutoSampler software.

Except for installing the cables and the mounting hardware, each of which may require up to 15 minutes to complete, none of these tasks should require more than 5 minutes.

Before you open the carton your 8200 CX AutoSampler arrived in, check for any evidence of damage, e.g., crushed corners, forklift punctures, water stains. If you detect any damage, notify Varian immediately at

Varian Chromatography Systems
2700 Mitchell Drive
Walnut Creek, California 94598-1675
Attention: Manager of Customer Service
Phone (510) 939-2400

or contact your local Varian Sales/Service Center.

UNPACK AND INSPECT THE 8200 CX AUTOSAMPLER

UNPACK THE 8200 CX AUTOSAMPLER

Your 8200 CX AutoSampler will have arrived in a single shipping carton. Arrows indicate the top of the carton.

To unpack the AutoSampler, proceed as follows:

1. Place the carton on the floor near the GC on which you plan to install the AutoSampler. Make sure the carton is top-side up.
2. Cut the two plastic shipping straps and lift the top cover. Remove the inner cover with its attached foam support blocks.
3. Use the two hand holes to lift the inner liner and its attached support blocks from the carton.

NOTE: Save the shipping carton in case you need to ship the instrument back to the factory.

4. Open the inner carton and check that it contains the Standard Accessory Kit (P/N 03-908989-90). Check the contents of the Standard Accessory Kit against the enclosed list. If there are discrepancies or items missing, notify Varian immediately.
5. Lift the AutoSampler up and out of the shipping carton and place it upright on the bench next to the GC.



Do not lift the AutoSampler by the storage module. Rather, lift at the upper left and lower right corners of the AutoSampler to avoid damaging the storage module hinge.

NOTE: Do not overlook the syringe that accompanies your AutoSampler. The syringe is packed in a separate small container in the shipping carton beneath the AutoSampler.

INSPECT THE 8200 CX AUTOSAMPLER

Carefully inspect the 8200 CX AutoSampler for damage. If you find any damage, or if you find that parts are missing, notify Varian immediately.

REMOVE THE CARRIAGE TIE DOWN

To remove the carriage tie down, proceed as follows:

1. While holding the syringe carriage, cut the plastic tie wrap that holds the syringe carriage to the top cover.
2. Lower the syringe carriage to the stop.
3. Carefully remove the tie wrap from the AutoSampler.

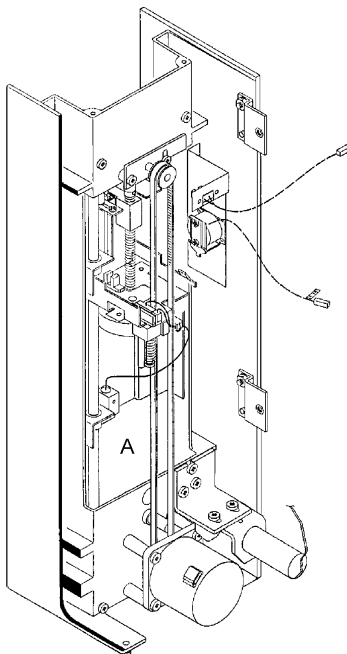

A Syringe Carriage

GC TOP COVERS AND THE 8200 CX AUTOSAMPLER

If you are connecting your 8200 CX AutoSampler to a Varian 3000 Series GC that was manufactured before March 15, 1990, it will not have been equipped with an AutoSampler-compatible top cover. The following table lists the GC Cover Upgrade Kits for these older GCs.

Kit Part Number	Description
03-918404-91	Star 3400 CX/8200 CX Cover Upgrade Kit
03-918405-91	3410/8200 CX Cover Upgrade Kit
03-918408-91	Star 3600 CX/8200 CX Cover Upgrade Kit

Each installation kit comes with a list of parts. Carefully check the contents against the list to make sure you have received all of the parts. If you find any parts missing or if there are discrepancies, notify Varian.

INSTALL THE MOUNTING HARDWARE ON THE GC TOP COVER

VARIAN GAS CHROMATOGRAPHS

Left-hand AutoSampler mounting is standard on the 3350, Star 3400 CX and 3410 GCs, and for the left injectors of the Star 3600 CX GC. You can mount the 8200 CX AutoSampler in the front or rear positions. With left-hand mounting, the storage module swings open to the left of the injector. The Standard Accessory Kit (part number 03-908989-90) shipped with the AutoSampler includes all necessary mounting hardware.

An optional right-hand mount in which the storage module swings to the right is available for right-hand injectors on the Star 3600 CX GC. Thus, you can install the AutoSampler over the right or left injectors and in the front or rear positions. The Star 3600 CX Cover Upgrade Kit (P/N 03-918408-91) includes all of the parts required to install the AutoSampler in the right- and/or left-hand configurations.

To install the AutoSampler on a ...	You will need....
GC with a single injector	a single long mounting plate.
GC with dual injectors	one short mounting plate and one long mounting plate.
GC with three injectors (Star 3600 CX GC only)	one long mounting plate and two short mounting plates.
Other gas chromatographs, see Installation on HP 5890 Gas Chromatographs on Page 44 or 8200 CX Parts and Supplies on Page 167.	

INSTALL THE MOUNTING PLATES

To install the mounting plate(s), proceed as follows:

1. Set the mounting plate(s) on the top cover so that the screw holes align.
2. Secure the plate(s) to the new top cover with two 8-32 screws and washers. The screws go through the slightly elongated openings in the plate. The elongation permits you to position the AutoSampler over the injector nut.

When installing more than one plate, position the long plate at the rear.

8200 CX Injection Module

- A Short Plate
- B Long Plate

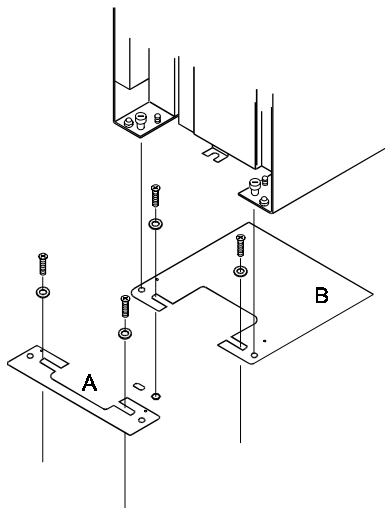

CONNECTING THE 8200 CX CABLES

Prior to installing the 8200 CX AutoSampler, you must connect cables to the GC, and to the PC or Varian Workstation.

CONNECTING THE SERIAL CABLE TO A PC OR VARIAN WORKSTATION

- To install this hardware, you will need a **Phillips** screwdriver.

To install the AutoSampler to the computer serial cable, proceed as follows:



WARNING: SHOCK HAZARD

**Dangerous Voltages Exposed When High Voltage Cover is removed.
Unplug Power Cord.**

- Turn off the power to both the GC and the AutoSampler. The Varian GC power switch is located on the back panel of the GC at the top left as you face the GC. The AutoSampler switch is located at the lower left rear of the AutoSampler.
- Remove the brown cover from the AutoSampler. Two screws hold the top of the cover and two screws hold the back of the cover.

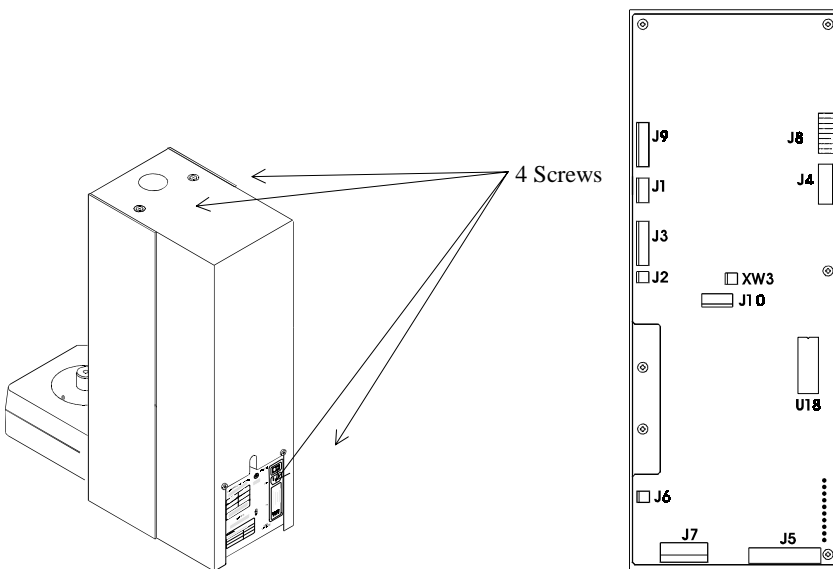

- Remove the cable attached to connector J3 on the AutoSampler controller board. Release the cable from the strain relief-grounding point where it is attached to the AutoSampler frame.
- Locate the AutoSampler-computer serial cable (P/N 03-918965-00) and plug it into J3.

Communication Connections between GC Workstation and Automated SPME/8200 with GC Workstation Control

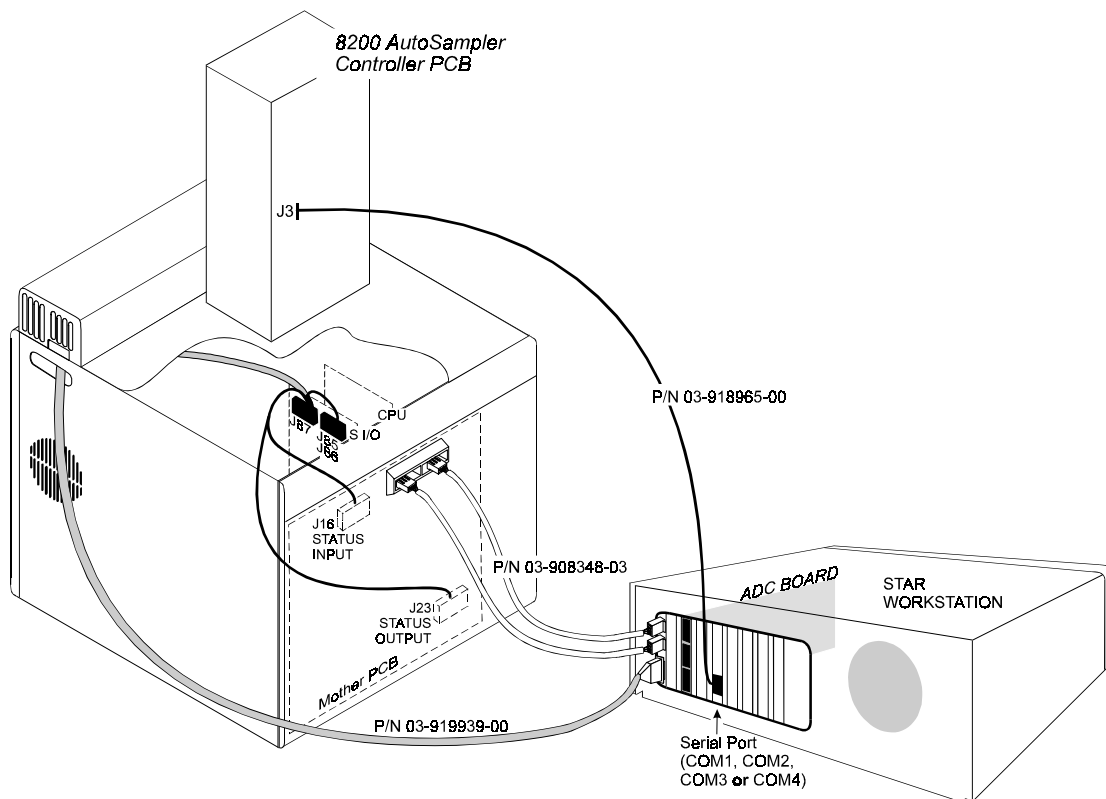

- Attach the part of the cable with the exposed shield to the strain relief-grounding point on the AutoSampler frame. Attach the other end of the cable to one of your computer's serial (COM) ports.

NOTE: If your PC will be used to control a Saturn, you will have to use a port other than COM1.

NOTE: Since some computer manufacturers use 25-pin serial ports, the COM connection may require an adapter.

- If you plan to use the SPME Injection at this time, proceed to **Installing SPME II Hardware** on Page 27. Otherwise, replace cover on AutoSampler. Continue to the next step.

7. If you are using a Varian Workstation with GC control, GC Workstation cable P/N 03-919939-00 must be used.
8. If you are using a PC to control the 8200, proceed to **Connecting the Status Cable to a Varian GC (PC Control Only)**. Otherwise, replace cover on autosampler. Proceed to **Mount the 8200 CX AutoSampler** on Page 30.

CONNECTING THE STATUS CABLE TO A VARIAN GC (PC CONTROL ONLY)

- To install this hardware, you will need a **Phillips screwdriver**.

To install the status cable, proceed as follows:



**WARNING:
SHOCK HAZARD**

**Dangerous Voltages Exposed When High Voltage Cover is removed.
Unplug Power Cord.**

1. Turn off the power to both the GC and the AutoSampler. The Varian GC power switch is located on the back panel of the GC at the top left as you face the GC. The AutoSampler switch is located at the lower left rear of the AutoSampler.
2. Remove the top cover from the Varian GC.

**Communication Connections between PC and Automated SPME/8200
(No GC Control from PC)**

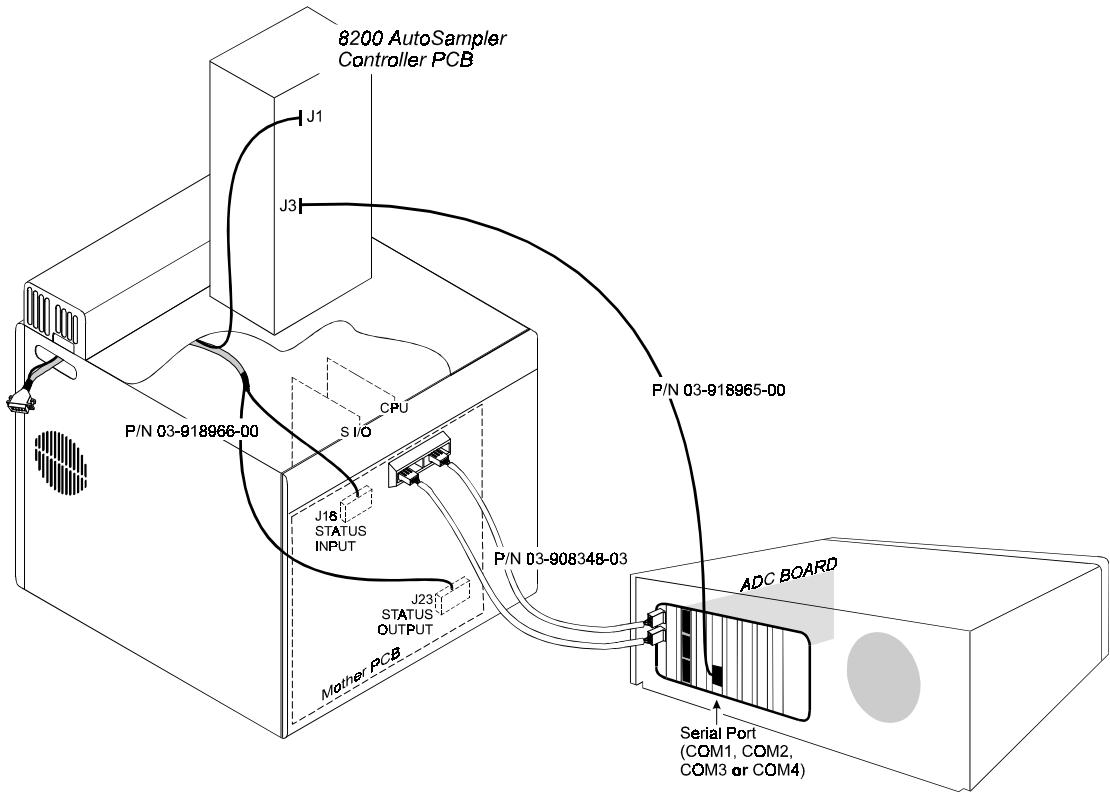

3. Locate the GC-AutoSampler status cable (P/N 03-918966-00). Plug the 4-pin Molex connector into J16 and the 5-pin Molex connector into J23.

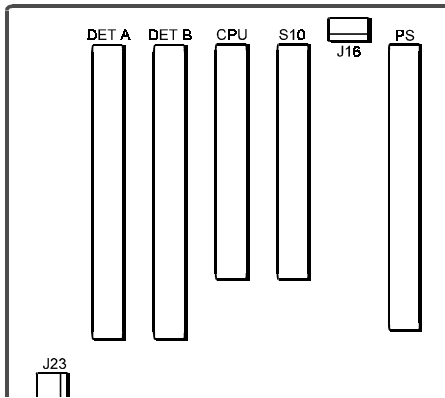

You may need to remove one or two detector boards to gain access to J23.

You may also need to remove the Serial board to gain access to J16.

4. Replace any printed circuit boards that you removed from the GC.
5. Route the other end of the cable through the opening at the rear of the GC. Attach the strain relief clamp to the GC rear panel. The cutout in the upper left corner of the panel is notched for mounting hardware in any of the four corners of the GC. The 9-pin connector should be outside the GC.

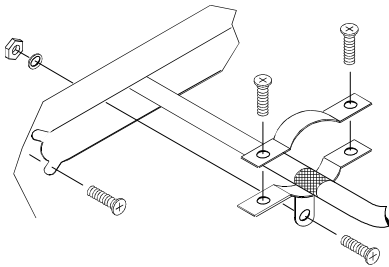

6. Plug the 5-pin connector on the other end of the status cable into J1 on the AutoSampler board. Check that all connectors are installed with the correct orientation (the connectors are keyed, but it is still possible to force them into the wrong position).

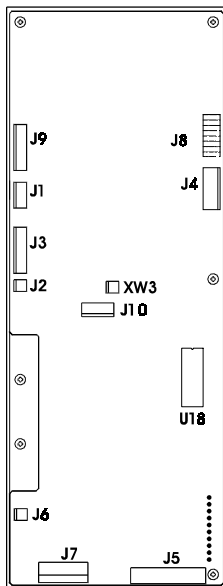

7. Replace the covers on the GC.
8. Replace the cover on the AutoSampler using the four Phillips screws.
9. Proceed to **Mount the 8200 CX AutoSampler** on Page 30.

INSTALLING SPME II HARDWARE

NOTE: AutoSamplers manufactured before June 1995 require PC board upgrades for SPME operation. This upgrade must be performed by a Varian field service engineer.

To install the SPME II hardware, you will need the following:

- Phillips screwdriver (medium)
- Flat-blade screwdriver (small)
- Static ground strap (included with SPME II kit)
- SPME ROM chip (P/N 03-910728-21), included with SPME II kit
- PC Board jumper, included with SPME II kit

INSTALL THE STATIC GROUND STRAP

NOTE: This procedure is required to protect the electronic components from damage by static discharge.

1. Locate the static ground strap, included in the kit. Secure the strap around your wrist. (Refer to the instructions included with the ground strap.)
2. Attach the other end of the ground strap (sticky side) to the lower side of the 8200 chassis, as indicated below.

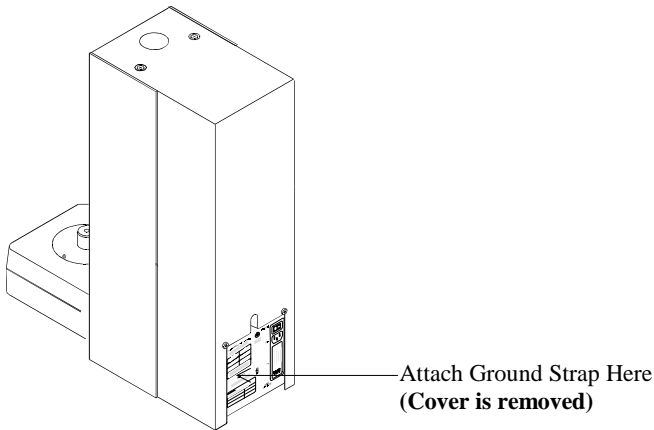

REPLACE THE OLD ROM

1. Using the small flat blade screwdriver, gently pry up one end of the old ROM on the AutoSampler controller board a small amount (see following diagram), then gently pry up the other end. Take care to avoid bending the pins.
2. Pry up alternate ROM ends until you can lift the old ROM out of its socket. Discard the old ROM.
3. Gently grasp the new ROM by the sides with the notch up, as shown in the following detail.

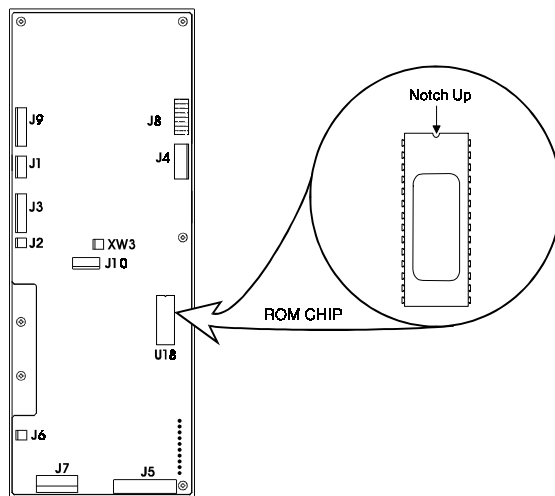

NOTE: Handle the ROM with care. You can easily damage it by bending the pins.

4. Line the new ROM up with the holes in socket U18, then apply gentle, even pressure as you press the new ROM into the socket.
5. Examine the ROM to make sure that all of the pins are in their appropriate socket holes.

NOTE: If you have bent any of the pins, remove the new ROM and reinstall it, repeating Steps 1 through 5.

6. Remove the ground strap from the chassis on the AutoSampler.
7. Place the jumper supplied in the SPME II kit on connector XW3 (located just above the center of the AutoSampler board). This allows the AutoSampler to run even if air pressure is absent.

INSTALL THE ADJUSTABLE VIAL RETAINER

1. Remove the screw holding the vial retainer bracket to the injection tower.
2. Holding the plastic door in one hand and the vial retainer in the other, gently pull the vial retainer away from the tower, then carefully lower the door from the top pivot pin.
3. Remove the retainer from the door. Install the adjustable retainer in its place.

4. Holding the plastic door in one hand and the vial retainer in the other, gently locate the door on the top pivot pin. Position the door and vial retainer bracket so that the locating pin fits into the small hole in the injection tower.
5. Reinstall the screw removed in step one.
6. If you are using a PC to control the 8200 CX, proceed to **Connecting the Status Cable to a Varian GC (PC Control Only)** on Page 22. Otherwise, continue to the next step.
7. Referring to the following diagram, replace the AutoSampler cover using the four Phillips cover screws.

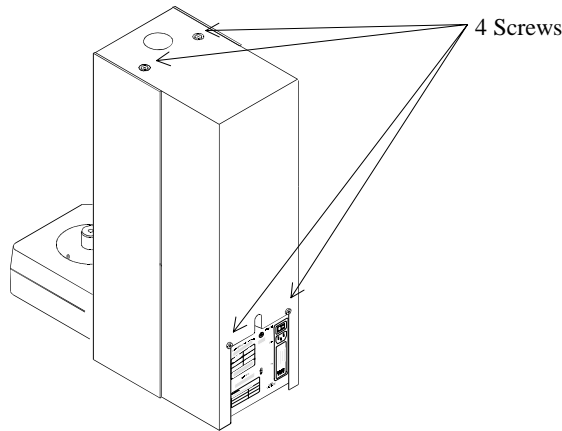

MOUNT THE 8200 CX AUTOSAMPLER

To mount the 8200 CX AutoSampler on the GC, proceed as follows:

1. Position the AutoSampler over the selected injector nut. If you have two injectors, and you use the rear injector, set the AutoSampler injection tower base on the long mounting plate aligned with the rear injector nut.
2. Carefully slide the AutoSampler on the mounting plate until the ball plunger screws drop into the ball plunger detents in the mounting plate.
3. With the storage module swung open for access, press down and engage the retractable captive screws in the injection tower base.

4. Turn the captive screws clockwise to secure the AutoSampler in place. See below.

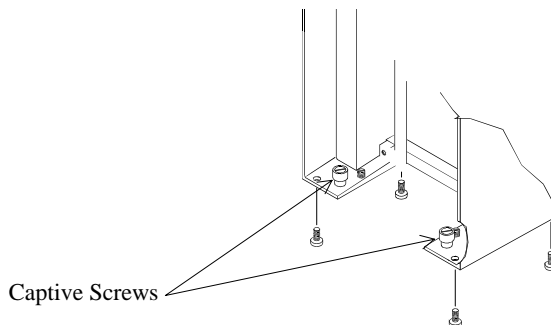

The spring-loaded balls in the ball plunger screws should rest in detents in the mounting plates. They serve to accurately position the AutoSampler. The ball plunger screws were preset in the chassis at the factory and should not require further adjustment. However, you can readjust them if the balls do not engage the detent properly, or if the AutoSampler rocks on its base after you have tightened the captive screws.

If you need to adjust the ball plunger screws, use a **thin, flat blade screwdriver**.

To adjust the ball plunger screws, proceed as follows:

1. Turn the captive screws slightly (clockwise or counterclockwise) with the thin flat blade screwdriver.
2. Test the adjustment by loosening the captive screws and sliding the AutoSampler in and out of the ball plunger detents. When properly adjusted, the AutoSampler will move smoothly on the mounting plate. Four threaded nylon feet in the injection tower base provide easy sliding for positioning, and prevent scratching of painted or finished surfaces.
3. The ball plunger screws extend 0.055 inches from bottom of the base of the injection tower.
4. Retighten the captive screws.

CONNECT POWER TO THE 8200 CX AUTOSAMPLER

To connect power to the 8200 CX AutoSampler, follow this procedure:

1. Before connecting the power cord to the rear panel of the 8200 CX AutoSampler, turn the power switch OFF. The power switch is located on the rear of the tower.
2. Check the voltage rating on the serial number label, and the position of the white pin in the power entry module to be sure they agree with the voltage available on site.

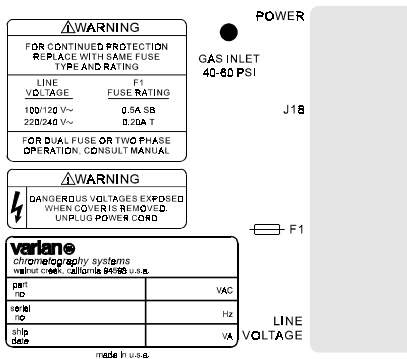

3. If the two values in Step 2 agree, proceed to Step 10.
4. If the two values in Step 2 fail to agree, proceed as follows, referring to the diagram below. You will need **small needle-nosed pliers** to perform this procedure:

Voltage Selector Card Orientation

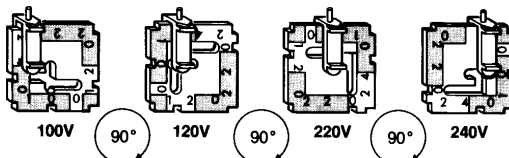

5. Remove the fuse block/cover assembly from the power entry module.
6. Use the small needle-nosed pliers to carefully pull the voltage selector card straight out of the housing.

7. Orient the selector card so that you can read the voltage to be used at the bottom (the indicator pin points out).
8. Insert the voltage selector card into the housing with the desired voltage showing on the edge. The printed side of the selector card should face upwards toward the IEC connector.
9. Replace the cover and check that the pin is showing in the hole of the desired operating voltage.
10. Connect the power cord to J18 on the panel of the AutoSampler. Plug the other end of the power cord into a wall receptacle.

NOTE: If you intend to operate the AutoSampler at a specific voltage for an extended period of time, write the operating voltage on the label on the rear panel of the AutoSampler.

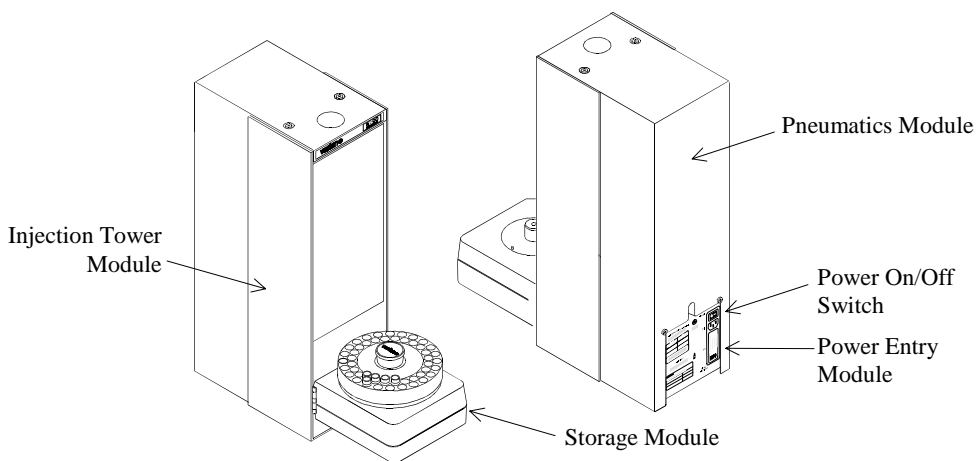

VIAL RETAINER ALIGNMENT

- A Vial Retainer Arm Block
- B Vial Retainer Arm
- C Syringe Needle Guide Arm
- D Adjusting Screw

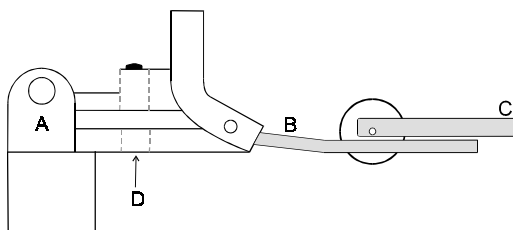

Follow Steps 1 through 5 on Page 58, **Align the Syringe Needle with the Injector Port.**

1. Lower the carriage by hand until the syringe needle guide arm is level with the vial retainer arm
2. Adjust setscrew so that the retainer arm just clears the guide arm.
3. Raise carriage to upper limit of travel, then lower until it rests on the stop solenoid.
4. Close the storage module.

INSTALLING SOFTWARE

ON A PC OTHER THAN A STAR CHROMATOGRAPHY WORKSTATION (INCLUDING A SATURN PC)

To install the 8200 AutoSampler software on a PC other than a Star Chromatography Workstation, proceed as follows:

1. Start Microsoft Windows.
2. Insert the 8200/SPME PC Control Software (P/N 03-910730-00) diskette into drive A (or drive B).
3. Open the Program Manager and choose Run under File in the menu bar.
4. Type **a:setup** (or **b:setup**) and press **Enter**.
5. Follow the instructions on the screen.

6. Proceed to **How to Configure the AutoSampler** on Page 36.

ON A STAR CHROMATOGRAPHY WORKSTATION



CAUTION

Do not install the 8200/SPME PC Control Software (P/N 03-910730-00) on your Star Workstation. If you install the PC Control Software on a Star Workstation, the Star Workstation software will be overwritten.

If you have purchased the 8200 AutoSampler software as an add-on to your Star Chromatography Workstation, you can now install the new software.

To install the 8200 AutoSampler software as an add-on to the Star Chromatography Workstation, proceed as follows:

1. Verify that version 4.5 (or later) of the Star Chromatography Software is installed on your computer. You can do this by selecting **About...** under **Help** in the menu bar of any of the Star Workstation applications and checking the version number. If you are running an earlier version, install version 4.5 (or later) before proceeding.
2. Close all Star Workstation Applications, then double-click on the Module Installation icon in the Varian Star 4.5 program group of the Program Manager window. This brings up a dialog box showing a list of the currently installed drivers for the Star Workstation.
3. To add or update the 8200 driver, press the **Add...** button. This displays the Add Module Drivers dialog box.
4. Click on Floppy Drive/Directory. Specify the location from which you want to install the driver. By default this location is A:\. If the floppy drive used for the installation is not A:, substitute the appropriate designation (for example, B:\).
5. Insert the floppy disk for 8200/SPME II Driver Software (P/N 03-910729-00) in the specified floppy drive, then press the **OK** button. The Add Module Drivers dialog box will now list the drivers available for installation.
6. Click on **Install All**. An asterisk will be added in front of the driver to indicate that it has been installed.

7. Click on **Done**. You are returned to the Varian Star Workstation Drivers window. Verify that the 8200 driver has been added to the list of installed drivers in the dialog box.
8. Click on **Done**. This completes driver installation. You can use the Module Installation program any time to add or remove drivers from your Workstation. For more details on the program's operation, see the Workstation's On-Line Help files.

HOW TO CONFIGURE THE AUTOSAMPLER

Once you have installed the 8200 AutoSampler software, the first thing you will want to do is to configure your GC for AutoSampler operation. You do this from the AutoSampler's System Control Configuration page.

NOTE: Before you configure the software for AutoSampler operation, be sure you have turned on the AutoSampler. The power switch is located on the rear of the tower.

To configure the AutoSampler, proceed as follows:

1. In Windows, open the Program Manager.
2. Double-click on the **System Control** icon in the Varian Star group of the Program Manager.

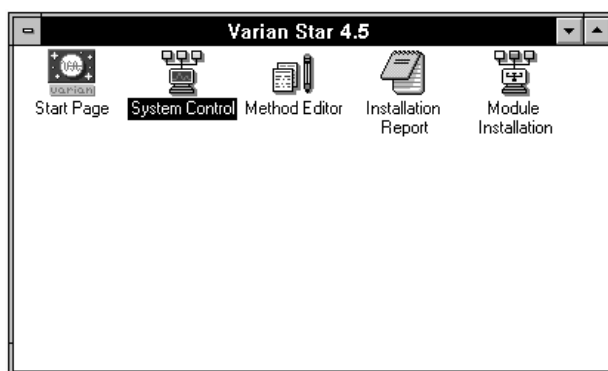

The System Control Configuration window appears. The Configuration window accommodates up to four AutoSamplers, each connected to a different GC, at any given time. A quadrant of the System Control Configuration screen is reserved for each of the four instruments, i.e., Instrument 1, Instrument 2, Instrument 3, and Instrument 4.

Each quadrant includes an AutoControl Module box and a parameters button. The header in each quadrant identifies the instrument, operator, and current state of the AutoSampler connected to that instrument (e.g., Ready, Not Ready, Running, etc.).

If the 8200 driver is installed and no COM Ports have been previously configured, System Control will display the “Setup COM Ports” Dialog Box. Otherwise, select the **Setup COM Ports** menu item from the **Instrument** menu to display the Setup COM Ports Dialog Box.

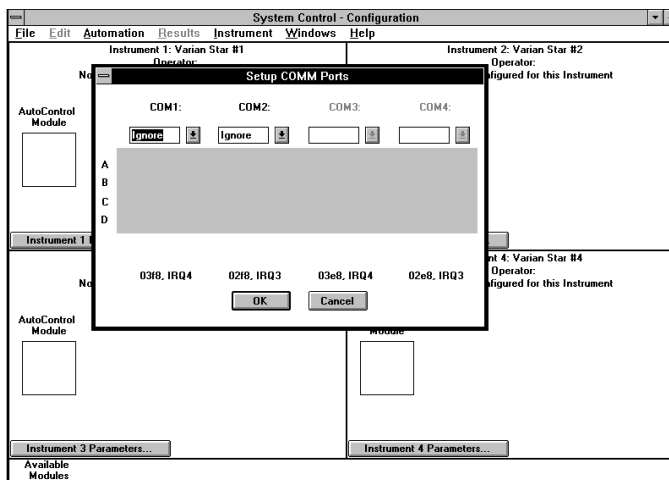

NOTE: Until you have configured an Instrument, a Help screen will also appear whenever you open the System Control Configuration window. To close the Help screen, double-click on the Control menu box in the upper left-hand corner of the Help screen.

Each COM port that is installed will have an active Combo Box below its label. Uninstalled COM ports will have a disabled Combo Box. Use the Combo Box to select **8200** for each 8200 AutoSampler connected to a COM port. Select **Ignore** if nothing is connected to that COM port or if you want System Control to ignore the port. System Control will now be able to communicate with each serially controlled 8200 AutoSampler.

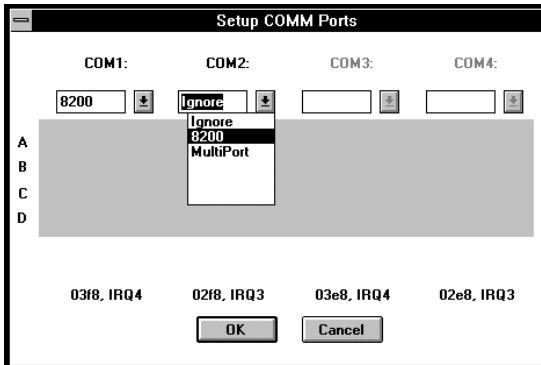

At the bottom of the Dialog Box is a display of the currently configured I/O Address and IRQ for each COM port that Windows is using. These should be the same values that are shown in the Ports Dialog Box accessed from the Windows Control Panel.

NOTE: Each COM port should have a unique IRQ setting. Interrupt sharing is not recommended where multiple 8200 AutoSamplers are configured.

Press the **OK** pushbutton to close the Dialog Box and wait for each 8200 to connect. When each 8200 connects, it will be represented by an icon at the bottom of the Configuration Window.

The icon will have a label reading 8200.nn where nn is the communication address that corresponds to the COM port to which the 8200 is connected. The COM Port communication addresses are assigned as follows:

COM1	COM2	COM3	COM4
24	28	32	36

1. Click on one of the buttons labeled **Instrument *n* Parameters ...** where *n* is 1, 2, 3, or 4. The Instrument Parameters dialog box for that instrument appears.

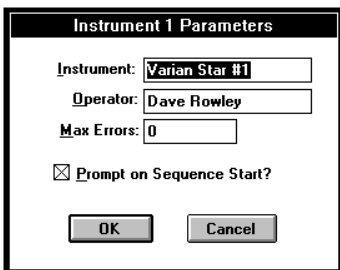

2. Enter a name for the instrument. The name may be up to 18 characters in length.
3. Enter your name as instrument operator. Your name may be up to 18 characters in length.
4. In the Max Errors field, enter the maximum number of nonfatal errors that you want the Star Chromatography Workstation to tolerate before terminating. The default value is 0.
5. Click on **OK**.
6. Click and drag the 8200 AutoSampler icon from Available Modules into the AutoControl Module of the Instrument workspace you selected in Step 1.

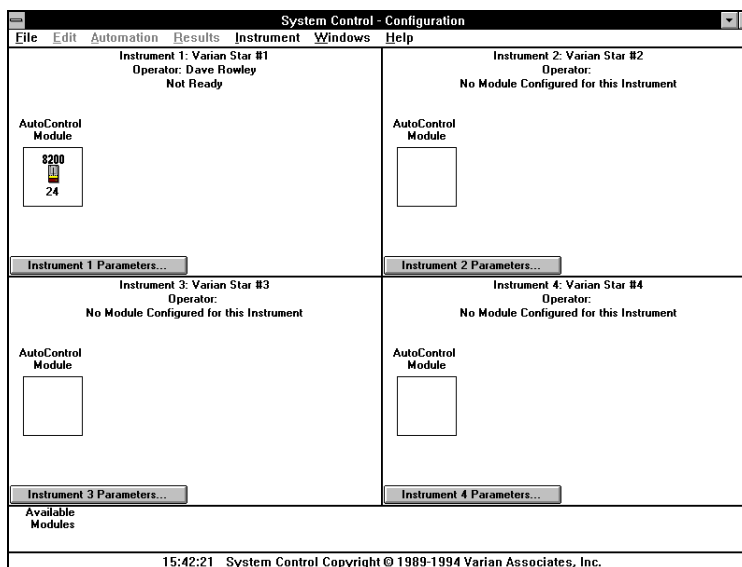

SPECIFY THE 8200 HARDWARE CONFIGURATION

1. Double-click in the quadrant of the System Control Configuration window corresponding to the instrument whose hardware configuration you wish to specify. Double-click on icon in the lower left corner. The following window appears.

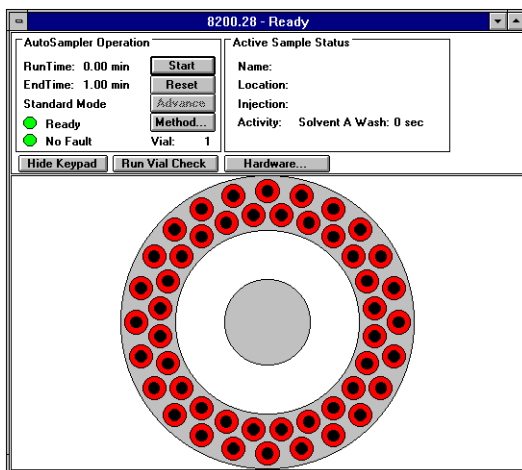

2. Click on the Hardware button as soon as it becomes active. The following window appears.

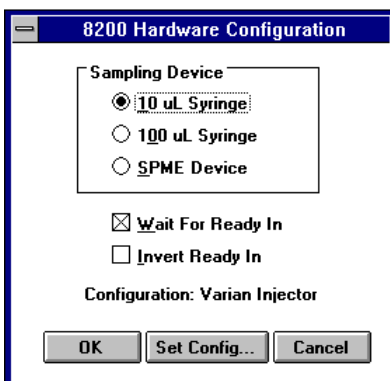

3. Under Sampling Device, select the sampling technique you wish to use, i.e., 10- μ L syringe, 100- μ L syringe, or SPME device.
4. There are two check boxes that configure the synchronization signals for different combinations of hardware. These boxes must be configured as follows:

AutoSampler Mode	Instrument	“Wait for Ready In”	“Invert Ready In”
SPME or Liquid Sampling	3400/3600 <i>with</i> Star Workstation Control	Unchecked	Unchecked
SPME or Liquid Sampling	3400/3600 <i>without</i> Star Workstation Control	Checked	Checked
SPME or Liquid Sampling	3400/3600 <i>with</i> Saturn MS	Checked	Checked
SPME or Liquid Sampling	HP 5890 Gas Chromatograph	Checked	Unchecked

If the system is configured for PC-controlled liquid sampling **ONLY** (i.e., the SPME upgrade and ROM has **NOT** been installed), then the “**Wait for Ready In**” box must be unchecked in all cases except with the HP 5890, where it must be checked for proper operation. The “**Invert Ready In**” box will be grayed (inactive) when liquid sampling-only configurations are used.

Select a Configuration File

There are four 8200 Configuration Files supplied with the 8200 CX AutoSampler software:

varian.cfg	for Varian 3400, 3600 GCs
jadev.cfg	for Varian 3400, 3600 GCs with Jade Valve on Injector
hp.cfg	for Hewlett-Packard 5890 GCs
jadehp.cfg	for Hewlett-Packard 5890 GCs with Jade Valve on Injector

The default configuration file is varian.cfg. If you are using a Varian GC without a Jade Valve, you do not need to select a configuration file; the varian.cfg will be selected automatically. Otherwise you must select the a configuration file according to the following scheme:

GC	With Jade Valve on Injector	Without Jade Valve on Injector
Varian 3400/3600	jadev.cfg	varian.cfg
HP 5890	jadehp.cfg	hp.cfg

To select a configuration file, proceed as follows:

1. Click on **Set Config...** in the 8200 Hardware Configuration window.
2. Select the floppy drive in which the installation diskette is inserted. Click on **OK**. The configuration files, which end with a .cfg suffix, appear on the left side of the window. **NOTE:** The location of these files in a PC-controlled system (not a Star Workstation) will be C:\STAR.
3. Select the configuration file corresponding to the injector that you will be using.

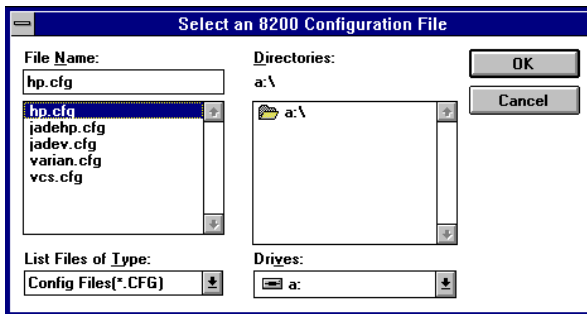

4. Confirm your injector choice by clicking on **OK**.

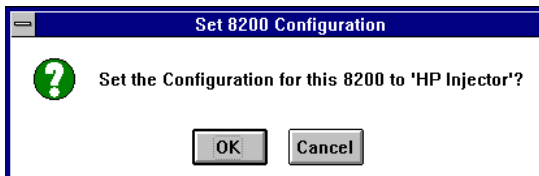

5. Click on **OK** in the 8200 Hardware configuration window.

FINAL INSTALLATION CHECK

Installation of the 8200 CX AutoSampler is now complete. Before setting up an injection method for the AutoSampler, make sure you have

- Installed the top cover.
- Installed the mounting hardware.
- Installed the serial and status cables.
- Installed the SPME hardware (SPME Injection only).
- Mounted and secured the AutoSampler to the mounting plates.
- Checked that the operating voltage label and voltage selection pin agree with the on-site power rating, that a properly rated fuse has been installed, and that the power cord has been connected.
- Installed the software.

If you plan to use ...	Proceed to ...
Liquid Injection	Section 3, Liquid Injection Setup
SPME Injection	Section 5, SPME Injection Setup
SPME III	Section 7, SPME III with Agitation
Ambient Headspace Injection	Section 8, Ambient Headspace Injection Setup
Large Volume Injection	Section 10, Automated Large Volume Injection Setup and Operation

INSTALLATION ON HP 5890 GAS CHROMATOGRAPHS

The HP 5890 GC requires special top covers and mounting hardware. The HP 5890 also requires an injector spacer for Liquid Injection to increase the injector height.



**WARNING:
BURN HAZARD**

Hot Surfaces are Exposed. Cool down the GC before beginning the following procedure.

Remove the HP 5890 GC Top Covers and Injector

To remove the HP 5890 GC top covers and injector, proceed as follows:

1. Remove the snap-on injector cover from the top right of the GC.
2. Remove the screwed-down cover from the top of the GC.

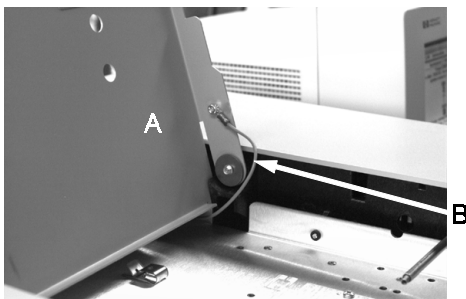

A Screwed-down Cover
B Grounding Strap

3. Disconnect the grounding strap from the right-hand cover.
4. Remove the two screws from the sides of the injector.

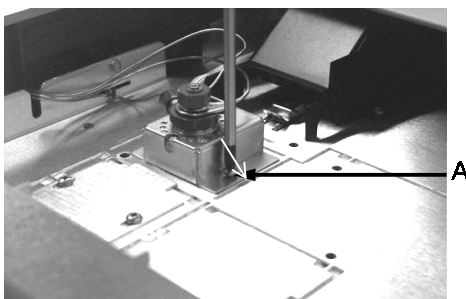

A HP Injector Screws (2 places)

5. Open the GC oven.
6. Remove the GC capillary column if installed.
7. Loosen the two screws holding the injector insulator cup, and remove the cup.

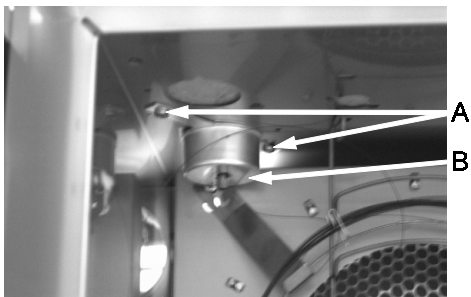

A Screws

B Cup

8. Close the oven.

Install the Varian Injector Spacer

To install the Varian injector spacer, proceed as follows:

1. Using a pair of scissors, cut a 7 x 1-1/4-inch strip from the roll of fiberglass insulation (P/N 24-000741-00) included in your top cover installation kit.

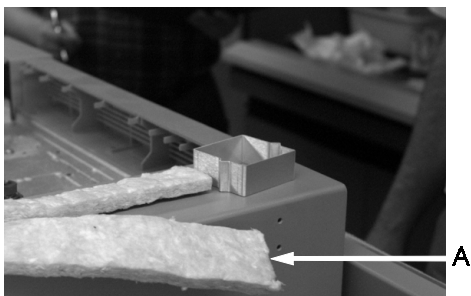

A Insulation

2. Lift the injector free of the plenum.
3. Place the cookie-cutter-shaped injector spacer (P/N 03-918866-00) on the plenum surface.

- Place the fiberglass insulation so that it surrounds the base of the injector; then insert the injector into the injector spacer.

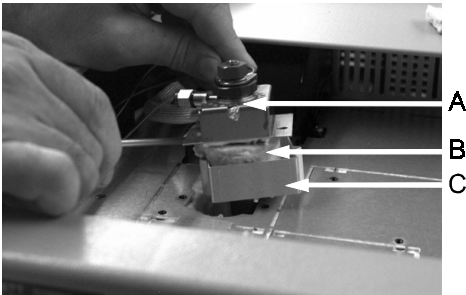

A Injector Cover
B Insulation
C Injector Spacer

- Insert the two long (4-pitch x 30-mm-long) metric Phillips screws (12-168409-00) through the injector cover and the injector spacer, and into the plenum. Tighten the screws.

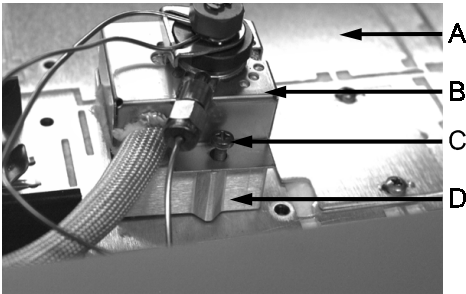

A Plenum
B Injector Cover
C Screw
D Injector Spacer

INSTALL THE VARIAN TOP COVERS

To install the Varian top covers, proceed as follows:

1. Install the small support to the left (as you face the GC oven) of the elevated injector with the two (8-pitch x 3/4-inch-long) self-tapping Phillips screws (P/N 10-321108-12).



A Small Top Cover Support

2. Install the large top cover support (P/N 03-918864-00) to the right (as you face the GC oven) of the elevated injector with the two short (4 pitch x 6-mm-log) metric screws (P/N 12-168409-00). You will use two of the three mounting holes.

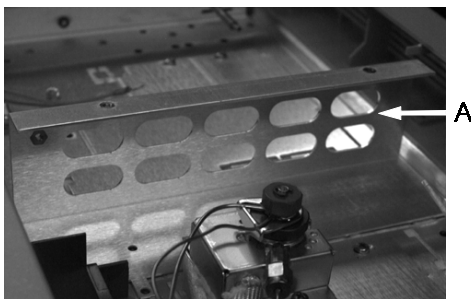

A Large Top Cover Support

3. Place the right-hand cover over the plastic stud at the upper right-hand corner of the plenum, and screw the flat-blade (8-32 thread x 5/16-inch) shoulder screw (P/N 12-999844-00) into the center support, making certain that the cover opens freely.

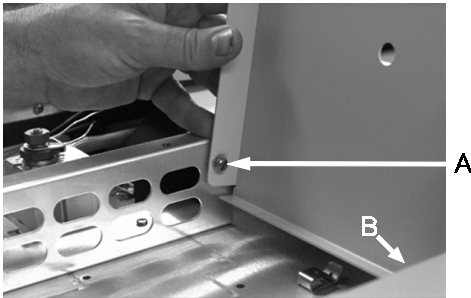

A Flat-blade Shoulder Screw
B Plastic Stud

4. Reconnect the grounding strap.
5. Install the left-hand cover.

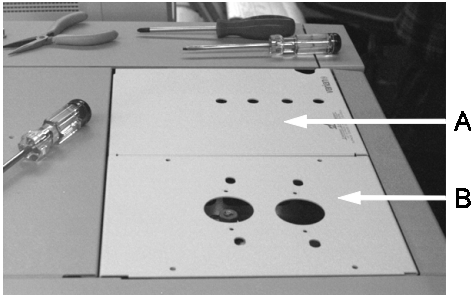

A Right-hand Cover
B Left-hand Cover

6. Insert and tighten the four (8-32 thread x 3/8-inch-long) screws (P/N 12-901131-00) that secure the left cover.
7. Reinstall the column (if it was removed above).

CONNECTING THE STATUS CABLE TO A HP 5890 GC

- To install this hardware, you will need a **Phillips screwdriver**.

To install the GC-AutoSampler status cable, proceed as follows:

1. Turn off the power to both the GC and the AutoSampler. The Hewlett Packard GC power switch is located on the right side of the GC at the lower rear as you face the GC. The AutoSampler switch is located at the lower left rear of the AutoSampler.
2. Remove the right side cover from the 5890 GC.
3. Locate the 5890/8200-AutoSampler status cable (P/N 03-918871-00). Plug the rectangular connector into the rear-most socket at the top right of the GC (Remote). The connector is keyed to fit the socket in only one way.
4. Route the other end of the cable out the GC. The 9-pin connector should be outside the GC and is only used to connect to the GC Varian Workstation or other data systems.

The SPME status cable provides a 9-pin connector at the rear of the GC where GC and AutoSampler status signals can be monitored.

The 9-pin connector is typically used with the GC Workstation but can be used with other integrators or data systems as well.

Location of Signals on DB-9 Connector

- Pin 1 Start In
- Pin 2 Unused
- Pin 3 Ready In
- Pin 4 Ground
- Pin 5 GC Ready Out
- Pin 6 GC Start Out
- Pin 7 Ground
- Pin 8 GC Ready Out
- Pin 9 GC Start Out

DB-9 Connector – SPME Status Cable

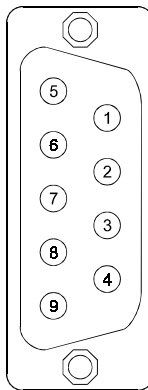

8200/HP 5890 Status Connector Pinouts – Cable Schematic

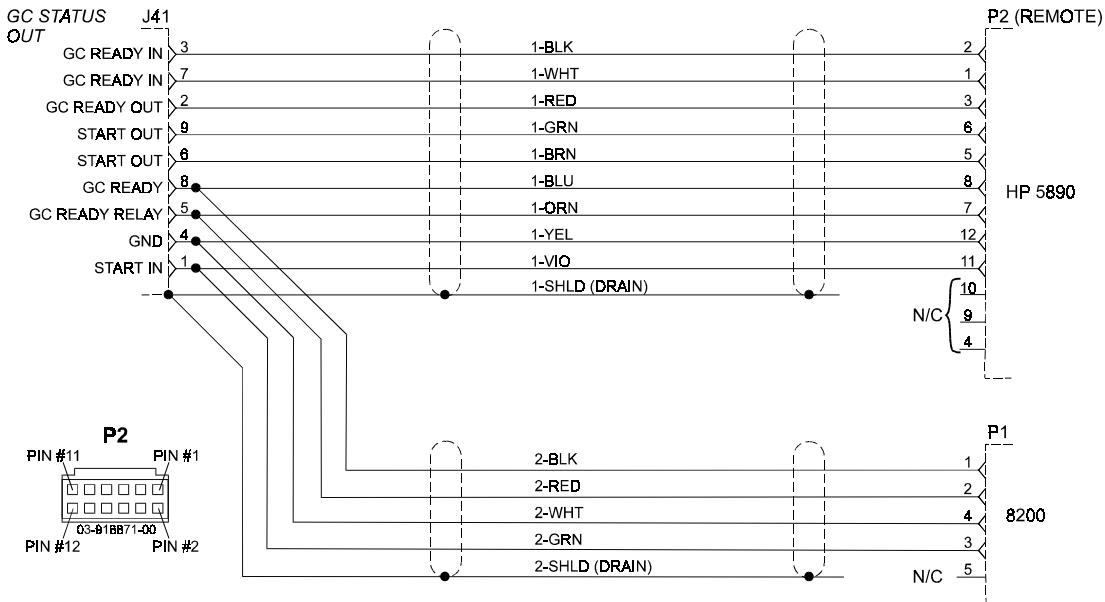

5. Remove the brown cover from the AutoSampler. Two screws hold the top of the cover and two screws hold the back of the cover.

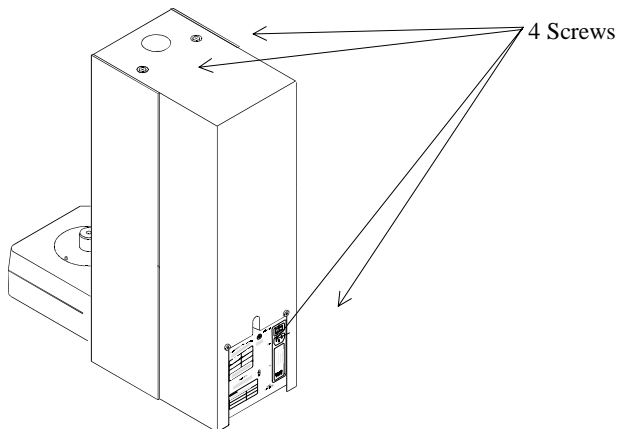

6. Plug the 5-pin connector on the other end of the status cable into J1 on the AutoSampler board. Check that all connectors are installed with the correct orientation (the connectors are keyed, but it is still possible to force them into the wrong position).
7. If you will be using the AutoSampler for SPME injections, place the jumper supplied in the SPME kit on connector XW3 (located just above the center of the AutoSampler board). This allows the AutoSampler to run even if air pressure is absent.
8. Replace the cover on the GC.

Continue with the serial cable installation Page 22.

Section 3

Liquid Injection Setup

To set up the 8200 CX AutoSampler for Liquid Injection, you will

- Connect the pneumatics.
- Install the solvent reservoir bracket.
- Route the solvent and waste lines.
- Install the syringe/needle assembly.
- Align the syringe needle with the injector port.
- Build a liquid injection method.

With the possible exception of connecting the pneumatics, none of these individual tasks should take you more than five minutes to complete.

NOTE: **Liquid Sampling requires removal of the SPME agitation accessory. If this device is installed on your autosampler refer to Changing From SPME III to Liquid Sampling on Page 98.**

CONNECT THE PNEUMATICS

The 8200 CX AutoSampler requires clean, chromatographically pure compressed (40 to 60 psig) air or nitrogen to operate. Because the gas contacts the solvent, a chromatographic grade gas is recommended. It is not necessary to use a separate air or nitrogen tank for the AutoSampler; nitrogen or air tanks that are currently used for detectors may have a 1/8-inch Tee fitting (P/N 28-691944-00) installed for pressurizing the AutoSampler.

NOTE: **If you have already connected the pneumatics, proceed to Install the Solvent Reservoir Bracket on Page 54.**

To connect the pneumatics, proceed as follows:



**WARNING:
EYE HAZARD**

Wear Proper Eye Protection. To prevent possible injury from a flailing gas line, shut off the gas supply valve before disconnecting the line.

NOTE: The pressure regulator in the AutoSampler will have been preset at the factory to 20 psi.

1. Connect the supply cylinder to the “barbed” fitting on the rear panel of the AutoSampler using the 1/8-inch OD polyurethane tubing from the Standard Accessory Kit. The barbed fitting is labeled GAS INLET 40-60 psig.

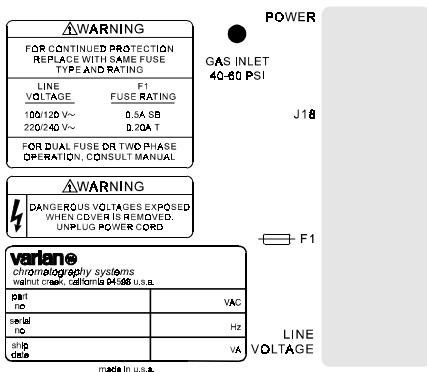

2. To make the connection at the GAS INLET, press the 1/8-inch OD tubing onto the barbed hose connector. Tug firmly on the tubing to make sure it is fully gripped on the fitting.

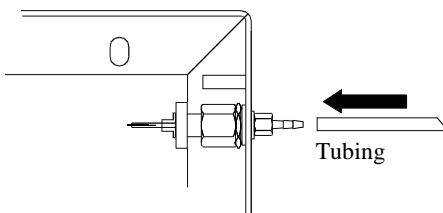

Detail of Gas Quick Connect Fitting

INSTALL THE SOLVENT RESERVOIR BRACKET

The solvent reservoir bracket holds two 180-mL solvent bottles and is secured to the left, upper rear corner of the GC side panel.

In this procedure, you will need the following:

- 2.5-inch strip of adhesive-backed neoprene tape. The tape comes with the Standard Accessory Kit (P/N 03-908989-90).
- No. 2 Phillips screwdriver.

To install the solvent reservoir bracket, proceed as follows:

1. Remove the upper left, rear corner panel screw.
2. Affix the 2.5-inch strip of neoprene tape to the rear surface of the reservoir bracket. Do not cover the bracket center hole.
3. Align the center hole of the reservoir bracket with the side panel screw hole. Secure the bracket to the GC with the panel screw.

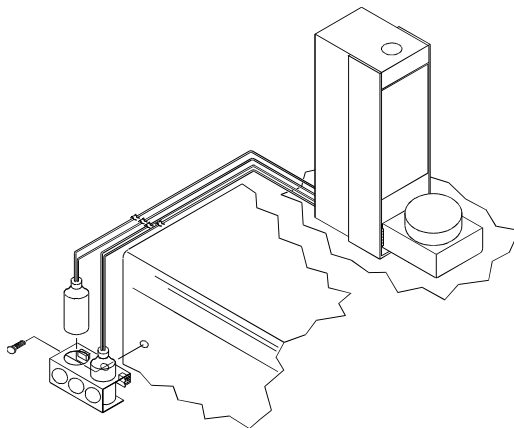

ROUTE THE SOLVENT AND WASTE LINES

Two sets of reservoir cap/line assemblies connect to their assigned solenoid valves in the pneumatics module. The reservoir cap/line assemblies were wrapped in plastic bags at the factory.

To route the solvent and waste lines, proceed as follows:

1. Before installing the reservoirs, unwrap the assemblies and check them for loose fittings.
2. The reservoir cap/line assemblies are tagged A and B. The 180-mL solvent bottles included in the Standard Accessory Kit are not labeled. To avoid later confusion, clearly label the bottles A and B. Check that the cap assembly A goes to solvent reservoir A and that cap assembly B goes to solvent reservoir B.
3. Route the Teflon® waste line attached to the AutoSampler to a waste bottle.

- To ensure an adequate drain from the solvent reservoir bottles to the waste bottle, position the waste bottle below the level of the waste cup. Avoid introducing kinks or low spots in the drain line.

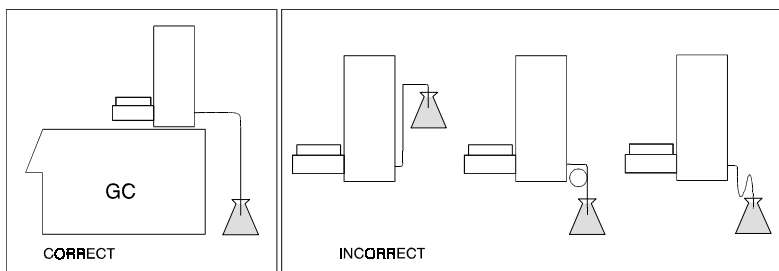

INSTALL THE SYRINGE/NEEDLE ASSEMBLY

To install the syringe/needle assembly on the syringe carriage, proceed as follows:

- Open the front door of the syringe mounting assembly by simultaneously and firmly lifting *both* side-locking tabs. Raise the tabs to the upper position. This may require considerable force, so hold the carriage assembly down with one hand. Alternatively, you can hold the mount down with both thumbs while you lift the tabs. The locking mechanism will become less stiff with use.

- A Solvent Line
- B Plunger Drive
- C Carriage
- D Side Locking Tabs
(2 places)
(Down: door closed;
red tab not visible)
- E Syringe Mount
- F Carriage Bracket
- G Needle Guide
- H Vial Retainer Arm
- I Red Tab
- J Syringe Mount Assembly
(door open)

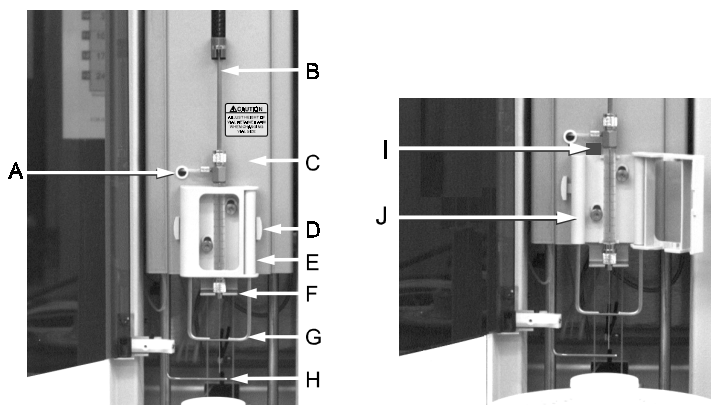

NOTE: A red tab is visible above the syringe mount assembly when the door is unlocked.

2. Referring to the diagram, guide the syringe needle into and through the small hole in the needle guide.
 - Press the syringe nut into the slot so that it rests on the upper surface of the syringe carriage bracket.
 - Press the syringe plunger button into the slot of the lead screw nut.
3. Close the syringe mount door.

NOTE: Check that the door is fully closed before pushing the side-locking tabs down. Then, holding the door closed and supporting the carriage with one hand, press the side locking tabs down with the other hand. This locks the syringe into position so that the syringe hex nut does not move. When the tabs are down, the door is locked and the red signal tab is not visible.

4. Connect the solvent line to the syringe side arm. Refer to the diagram.



**WARNING:
EYE HAZARD**

Wear Proper Eye Protection.

The Teflon® tube may disconnect from the syringe and spray solvent.

- Slide the knurled nut back from the end of the line.
 - Press the solvent line firmly against the machined shoulder of the side arm port.
5. Slide the nut up to the port and thread it onto the side port. Tighten the nut finger tight. Do not use pliers.
 6. If you notice a leak during operation of the AutoSampler, further tighten the nut with your fingers.

ALIGN THE SYRINGE NEEDLE WITH THE INJECTOR PORT

NOTE: When you initially mount the AutoSampler on the GC, the alignment of the syringe needle with the needle port of the injector nut may not be precise.

To align the syringe needle with the injector port, proceed as follows:

1. Check that the AutoSampler power switch is OFF. The power switch is located on the rear of the tower.

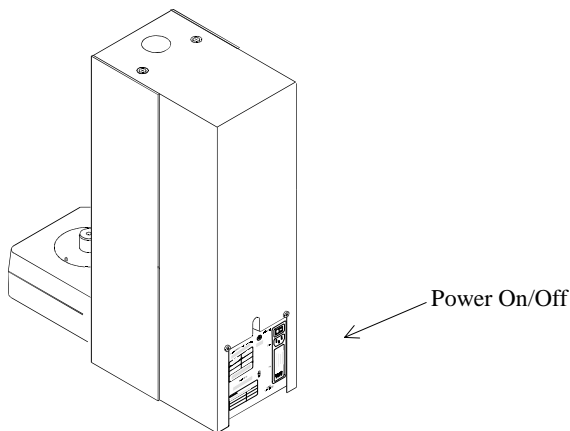

2. Press down on the storage module latch release (see below) and swing the module out to access the GC injector. When the storage module is swung out (with power off), a contact in the latch assembly activates that turns the syringe carriage stop solenoid on or off each time the carriage position sensor is interrupted.

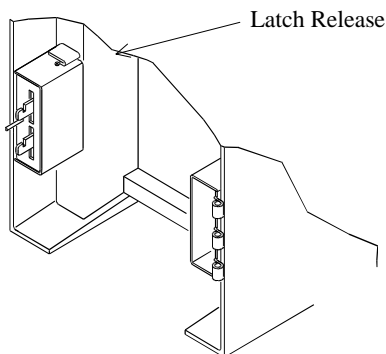

NOTE: Press the latch release down when closing the storage module.

3. Turn the GC power ON.
4. Turn the AutoSampler power ON.
5. Raise the syringe carriage from its rest position to its top limit. The stop solenoid toggles (you will hear a “click”) to allow you to lower the carriage by hand.



Take care that the carriage does not drop and damage the needle assembly.

6. Loosen the mounting plate screws (see below) so that the AutoSampler can be moved on the GC cover.
 - Lower the syringe carriage by hand until the needle tip is just above the GC injector needle port.

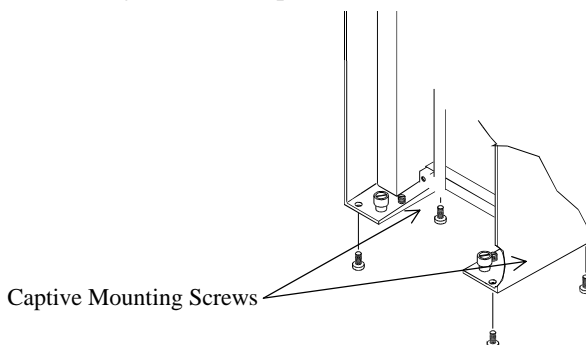

7. Carefully adjust the position of the AutoSampler to bring the syringe needle into precise alignment with the injector needle port.
 - Securely tighten the mounting plate screws
8. Lower the syringe carriage and puncture the injector septum two or three times to ensure that the syringe and syringe needle are properly aligned with the injector port.
9. To return the syringe carriage to its rest position, raise the syringe carriage to its upper limit of travel. Then lower the carriage a fraction of an inch until it engages.
10. Close the storage module.
 - Repeat this procedure each time you replace the injector septum.

BUILD THE LIQUID INJECTION METHOD

NOTE: Be sure you have selected the 10- μ L syringe setting in the 8200 Hardware Configuration Window (see Specify the 8200 Hardware Configuration, Page 39).

BUILD A NEW LIQUID INJECTION METHOD

The method is a record of all the instructions and parameters required to analyze your sample. The 8200 AutoSampler software allows you to create separate methods for each of your sample types.

To build a new Liquid Injection Method, proceed as follows:

1. Double-click on the “Method Editor” icon in the Varian Star group of the Program Manager.

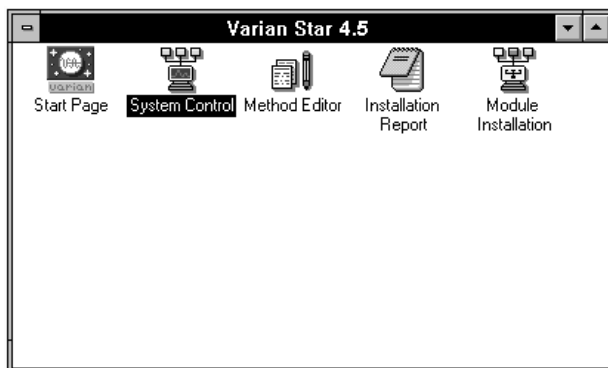

The Method Editor window appears with the Create/Open Method File in the foreground.

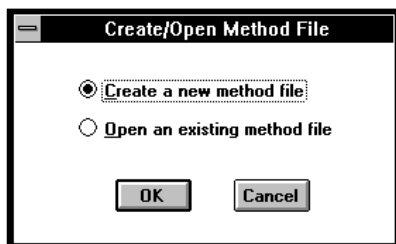

2. Select “Create a new method file” and click **OK**.

- The New Method Section window appears. Select “8200 Stand-Alone AutoSampler” in the Instrument Control section of the window.

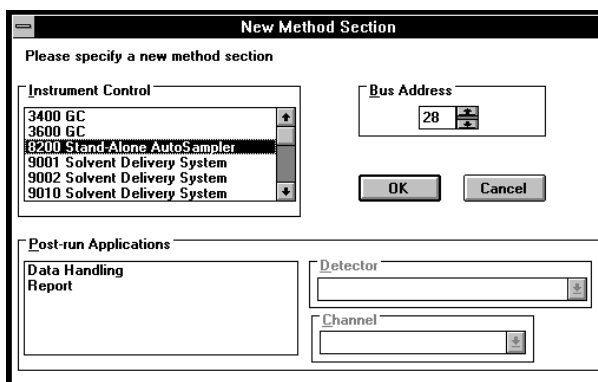

- Referring to the following table, use the up and down arrows to set the Bus Address in the New Method Section window. Click **OK**.

If you have connected the 8200 Serial Cable ¹ to the computer COM port labeled...	Set the Bus Address to...
COM1	24
COM2	28
COM3	32
COM4	36

- The New Method Section window closes and the 8200 Configuration icon appears in the lower left hand corner of the Method Editor window.
- Double-click on the 8200 Configuration icon. The Configuration window appears.

¹See Page 22, **Connecting the Serial Cable to a PC or Varian Workstation**.

SPECIFY THE CONFIGURATION WINDOW OPTIONS

1. Click on the downward-facing arrow to select the Carrousel Type: 48 Vials or 12 Vials.

The screenshot shows a 'Configuration' dialog box with the following sections:

- Carrousel Type:** A dropdown menu currently set to '48 Vials'.
- AutoSampler Timing:** A section containing an 'EndTime' field set to '1.00' with up and down arrows, and an unchecked 'Prep Ahead' checkbox.
- Sampling Modes:** A section titled 'Liquid' containing five radio button options: 'Standard Mode' (selected), 'Viscous Sample', 'Volatile Sample', 'Neat Sample', and 'User Defined'. Below these is an unchecked 'SPME Mode' radio button.
- Liquid Sampling Options:** A section containing two dropdown menus: 'Solvent A Wash' and '10 uL Syringe'.
- At the bottom are 'Save' and 'Cancel' buttons.

2. If Prep Ahead is checked, the AutoSampler will start preparing for the next injection before the GC is ready. This feature can be used to minimize the wasted time between runs. If this feature is used, however, the GC End Time should be entered. If a GC cycle time is entered that is shorter than the actual time, the sample will be held in the syringe before injection; this may result in loss of precision.

If you choose not to select Prep Ahead, leave the End Time setting at the default setting of 1.00 minute.

3. Under AutoSampler Timing, set the EndTime (minutes) using the up and down arrows to change the default value of 1.00 minute.
4. Select the sampling mode type under Liquid in the Sampling Modes section of the Configuration window. There are five sampling modes to choose from. The Standard, Volatile, Neat, and Viscous modes are pre-programmed with optimized parameters for specific samples. The fifth liquid mode, User-Defined, allows you to optimize the parameters yourself.

Standard Sample Mode. The standard sampling mode uses the solvent flush injection technique (Page 71, **Solvents and Solvent Reservoirs**). Good results are almost always obtained using this mode, so you should try it first if you are developing a new method.

The standard sampling mode is a solvent-flush, or sandwich method of sampling and injection. Parameters for this mode of sampling and their default values appear in the 8200 Quick Reference Guide.

- **Volatile Sample Mode.** Select the volatile sample mode when using samples with high vapor pressures at room temperature (e.g., methylene chloride, carbon disulfide, pentane).

To improve the performance of the AutoSampler when it is sampling volatile samples, some sampling parameters are automatically changed to the following:

- AutoSampler Injection Rate: 1.0 $\mu\text{L}/\text{sec}$
 - Upper Air Gap: Off
 - Sample Uptake Speed: 1.0 $\mu\text{L}/\text{sec}$
 - Pause Time: 6 seconds
- **Neat Sample Mode.** Select the neat sample mode when the wash solvent peaks would interfere with the chromatography of the sample. In the neat sampling mode, the sample is drawn into the syringe and then expelled or injected (suck-and-squirt) without the use of air or solvent gaps.
The Neat sample mode is also enabled when User Defined is selected and No is entered for Solvent Flush Sampling. As in the Neat mode, the sample is drawn into the syringe directly without air or solvent gaps and then injected; however when the User Defined mode is selected, you can more carefully tailor the sampling technique to your specific application.

The Neat Sampling sequence proceeds as follows:

- a) A sample (10 μL) is withdrawn from the sample vial at 5 $\mu\text{L}/\text{sec}$. The sample is expelled into the waste arm at 10 $\mu\text{L}/\text{sec}$. This step is repeated once.
 - b) A sample (10 μL) is withdrawn from the sample vial at 5 $\mu\text{L}/\text{sec}$. The sample is expelled (returned) to the sample vial at 10 $\mu\text{L}/\text{sec}$. This step is repeated six times.
 - c) A sample (10 μL) is withdrawn from the sample vial at 1 $\mu\text{L}/\text{sec}$. The sample is expelled (returned) to the sample vial at 10 $\mu\text{L}/\text{sec}$. This step is repeated three times.
 - d) A sample (5 μL) is withdrawn from the sample vial at 1 $\mu\text{L}/\text{sec}$. The lower air gap is formed. An upper air gap is not formed.
 - e) A specified amount of sample (Default = 1.0 μL) is injected into the GC injection port at 5 $\mu\text{L}/\text{sec}$.
 - f) The excess sample is expelled into the waste arm either before or during the syringe washing cycle.
- **Viscous Sample Mode.** Select the viscous sample mode when injecting samples with a higher viscosity than that of water, e.g., ethylene glycol.

Configuration

Carrousel Type: 48 Vials

AutoSampler Timing

EndTime: 1.00

Prep Ahead

Sampling Modes

Liquid

Standard Mode Viscous Sample

Volatile Sample User Defined

Neat Sample

SPME Mode

Liquid Sampling Options

Solvent A Wash

10 uL Syringe

Save Cancel

To improve the performance of the AutoSampler when it is sampling viscous samples, some sampling parameters are automatically changed to the following:

- AutoSampler Injection Rate: 1.0 $\mu\text{L}/\text{sec}$
- Solvent Wash Time: 40 seconds
- Needle Residence Time: 0.2 min.
- Sample Uptake Speed: 1.0 $\mu\text{L}/\text{sec}$
- Pause Time: 10 seconds
- **User Defined Mode.** Select the user mode when you want to more carefully tailor the sampling technique to your specific application.

The User Defined mode allows you to adjust the following parameters. Parameter defaults and ranges (in brackets) are also identified.

- **Solvent Flush Sampling** YES [No For Neat Sampling Mode]
- **Syringe Wash Time** (sec) 20 [5 - 180]
- **Air Dry After Wash** No [Yes For Air Dry]. May be set only when solvent flush is not used.

Select **Yes** if you want the syringe air dried following the WASH cycle. The duration of the air dry period is fixed by the syringe wash time.

NOTE: Frequent air drying shortens the lifetime of the syringe.

Solvent Plug Size (μL) 1.0 [0.1 to 3.0 or OFF]. This option specifies the size of the solvent plug used for a “solvent flush” sampling technique. The solvent in reservoir A is used to form the solvent plug.

Set the Solvent Plug Size to OFF if you do not want to have a solvent plug drawn into the syringe.

Vial Needle Depth (%) 90 [0-100]. This option determines the depth which the needle tip reaches into the vial. When set to 0, the needle just penetrates the septum. When set to 100, the needle tip almost touches the bottom of the standard 2-mL vial. Needle depths at 0 and 90 were determined with the internally machined glass vial (P/N 66-000121-00, conical internal construction). At 90%, the needle just reaches the bottom of the machined glass vial. Needle position varies slightly for different vial configurations.

Penetration of the needle into the standard 2-mL vial (03-949835-00) for various needle depths is shown below. This diagram also describes needle depths for the machined microvial.

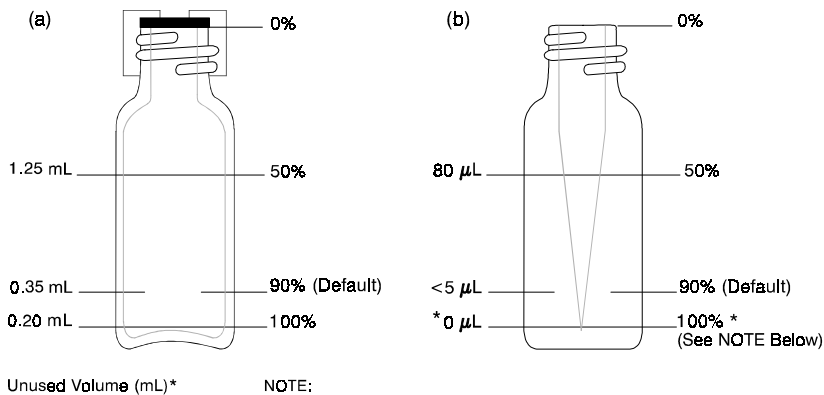

Unused Volume (mL)*

NOTE:
These figures are average and should only be used as a guide. Operator should re-verify these volumes on their instrument.

NOTE: Do not select the 100% setting when using microvials. A 100% setting causes the needle to bottom out in the vial and may damage the needle.

Adjust the vial needle depth only if you are using non-standard microvials, or if you must sample from the upper phase of a two-phase system. To compare the depths of non-standard microvials with a sample of the approved internally machined conical microvial, stand the two vials side-by-side on a level surface. If the bottom of the non-standard vial is lower than the bottom of the machined vial, increase the needle depth for very small samples. If you increase this value more than necessary, the needle may hit the bottom of the vial and damage the needle.

When sampling liquid/solid two phase systems, take care that the needle does not become clogged by solid particles. Particulates from the solid phase can plug the needle.

- **Uptake Speed** ($\mu\text{L}/\text{sec}$) 5.0 $\mu\text{L}/\text{sec}$ [1.0 to 5.0]. This option determines the rate at which the plunger is withdrawn while the syringe needle is in the sample vial. The greater the viscosity of the sample, the lower the sample uptake speed used.
- **Upper Air Gap** Yes [No For None]. May only be set if the solvent flush sampling option has been selected.
- This option determines whether or not an upper air gap is included in the solvent flush sample injection. The upper air gap volume is 0.5 μL .
- **Lower Air Gap** Yes [No For None]. May only be set if the solvent flush sampling option has been selected.

This option determines whether or not a lower air gap is included in the solvent flush sample injection. The lower air gap volume is 0.8 μL .

To reduce discrimination among wide boiling point components when using a vaporizing injector, eliminate the upper air gap and increase the size of the solvent plug.

You must include a lower air gap when using the hot needle injection technique. In this injection technique, the empty needle is heated in the injector before the sample is injected. This method provides more efficient vaporization of the sample.

- **Pause Time** (sec) 2 [1-10]. This option introduces a pause between the time the sample is completely drawn into the syringe and the time the syringe needle is withdrawn from the sample vial and injected. A longer pause time improves precision with viscous samples.

- Hot Needle Time (min) 0.00 [0.00 to 1.00]. This option specifies the length of time the needle resides in the hot injector before the sample is expelled from the syringe.
- Injection Rate ($\mu\text{L}/\text{sec}$) 5.0 [0.2 to 10.0]. The injection rate is the time used to expel the syringe contents into the injector. With sample sizes of 1 μL or less, the default injection rate (5.0 $\mu\text{L}/\text{sec}$) is usually optimum regardless of injector type. With larger injection volumes (>2 mL), use a slower injection rate to prevent flashback in vaporizing injectors. With non-vaporizing injectors, there is an advantage to a slow injection rate when doing solute focusing. To prevent broadening of early eluting peaks with split injection, use a fast injection rate of 10 $\mu\text{L}/\text{sec}$.
- Needle Residence Time (min) 0.00 [0.00 to 10.0]. This option specifies the length of time the needle remains in the injector after the sample has been expelled from the syringe. The residence time differs from the hot needle time; the residence time refers to the period that follows the injection of the sample. Include a needle residence time in the sample injection sequence with vaporizing injectors to minimize loss of volatiles.

SAVE YOUR METHOD

1. Once you have specified your Liquid Injection Method settings, click on Save. The Configuration window closes.
2. Double-click on the Control menu box of the Method Editor. A window appears that asks you whether you want to save the changes you have made to the method.
3. Click **Yes**. The Save Method File As window appears prompting you to name the new method.

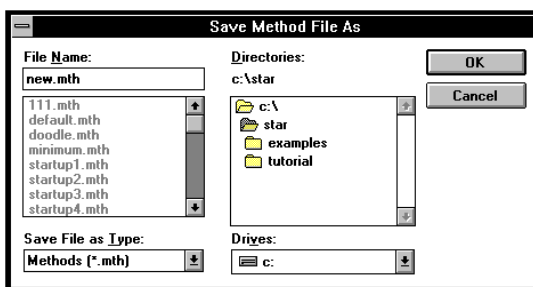

4. Assign a name of up to eight letters and/or numbers to the method, and click **OK**. The .mth extension will be added automatically.

FINAL LIQUID INJECTION METHOD CHECKLIST

Setup of the Liquid Injection Method for your 8200 CX AutoSampler is now complete. Before operating the AutoSampler as described in Section 4, make sure you have

- Connected the pneumatics.
- Installed the solvent reservoir bracket.
- Routed the solvent and waste lines.
- Installed the syringe/needle assembly.
- Aligned the syringe needle with the injector port.
- Built a liquid injection method

Section 4

Liquid Injection Operation

This section gives additional information that you will need to operate the 8200 CX AutoSampler using Liquid Injection. After familiarizing yourself with the information in this section, proceed directly to Section 11, **Performing Injections**.

SAMPLING

LOADING THE CARROUSEL

The carousel rotates clockwise and the vial position numbers increase counter-clockwise around the carousel. Observe this order when loading sample vials. Load sample vials according to the vial numbers shown on the carousel label.

The AutoSampler ignores vials without a septum. Seal all vials in the carousel that are to be sampled with a cap and septum.

SOLVENTS AND SOLVENT RESERVOIRS

Your choice of wash solvent and sampling solvent depends on your particular chromatographic application. Certain chromatographic applications may require two solvents of very different volatilities, viscosities or polarities. Or, you may want to select two wash solvents to ensure the sample is adequately washed from the syringe between injections. The objective is to find the best fit between solvent and sample for your particular application.

- **Filling the Solvent Reservoirs.** The solvent reservoir rack attached to the side of the GC holds two 180-mL solvent reservoirs. The sealed reservoir caps hold two lines. One line is the solvent line and leads from the bottom of the reservoir to the syringe. The other shorter line ends at the neck of the reservoir and controls the pressure to the reservoirs. Keep this line above the liquid level in the reservoirs at all times.



**WARNING:
EXPLOSION HAZARD**

Contents Under Pressure. Keep Bottles in Bracket and Liquid Level Below Vent Tube.

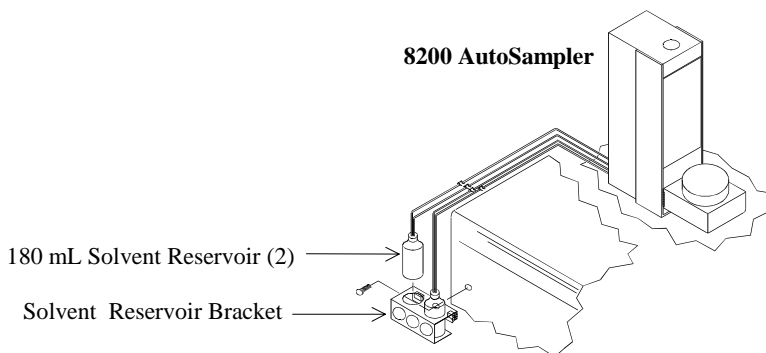

NOTE: When changing the solvent in the wash bottle from one solvent to another, use a new, dry filter. The porous filter absorbs solvent which cannot be completely removed by purging. After you change the solvents, purge the system: set the wash time to 180 seconds and repeat the wash cycle as many times as necessary.

- **Leaks in the Solvent Reservoirs.** When properly tightened by hand, the solvent reservoir caps and seals seal adequately. However, if you smell solvent or hear gas escaping from the solvent reservoirs, check to see if the cap is loose or cracked. If necessary, replace the cap and seal.
- **Venting the Solvent Reservoir.** Volatile solvents or toxic solvents must not be vented directly into the atmosphere. Under such conditions, vent the solvent reservoirs into exhaust ducts or fume hoods. Review your laboratory guidelines for handling and venting toxic and highly volatile solvents established by your department or organization.
- **Solvent Flush Mode Sample Injection.** The solvent flush or *sandwich* technique is the standard mode of injection used in the 8200 CX AutoSampler sampling sequence. This method of syringe loading is used unless you specify otherwise.

Refer to the following diagram for a description of the traditional mode versus the solvent flush mode of syringe loading. Once you have entered the values for the solvent plug and sample size, this mode of syringe loading is continued automatically until changed.

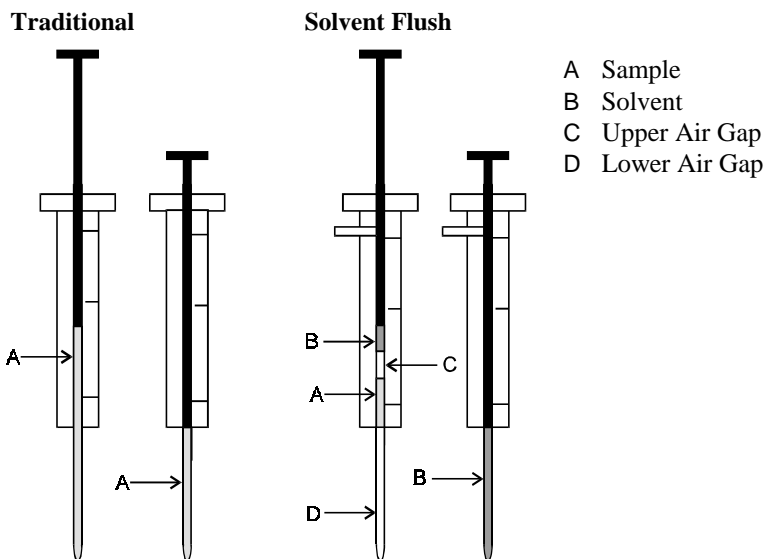

The solvent flush syringe loading sequence proceeds as follows:

1. The waste arm moves to the out position (over the injector). The syringe carriage moves down to insert the needle into the waste cup.
2. The syringe plunger withdraws from the syringe to its upper limit. Solvent flows from the side port into the syringe barrel and to the waste cup. Solvent flows through the syringe for a length of time equal to one-half the wash time.
3. The plunger moves down to the value entered for the solvent plug size. If you entered 2 μL , the plunger moves to the 2 μL mark on the syringe barrel.
4. The syringe carriage moves to its top position. In some methods, the syringe plunger moves up to introduce the upper air gap.
5. The carousel moves a sample vial under the needle. The syringe carriage moves down and the syringe needle pierces the septum and enters the sample vial. The syringe plunger moves up to draw a specified sample volume from the vial. The syringe plunger moves up to introduce the lower air gap. The lower air gap is within the needle and is not visible.

6. The carousel moves forward so that the syringe needle is over the injector. The syringe is lowered into the injector and the sample expelled.
7. The syringe carriage moves up to withdraw the needle from the injector, and the syringe is washed for the length of time specified in the method. You may select a wash solvent from either reservoir A, reservoir B, or reservoir A and reservoir B (reservoir A then reservoir B). If you choose to wash from reservoir A then reservoir B, the system defaults to reservoir A after the wash cycle is complete. This means that you must fill reservoir A with the solvent you want to use for your solvent plug.
8. If a second sample injection is called for in the sample list, the cycle begins again at Step 1.

NOTE: The wash cycle occurs during the run and does not affect sample turnaround time, except for samples with very short analysis times.

SAMPLE VIALS

The 48-vial carousel takes a standard 2-mL glass screw top vial with outside dimensions of 12 x 32 mm (12 x 35 mm with cap). The vial is sealed with a plastic screw cap with a 5-mm hole, and a white silicone rubber septum (8-mm diameter) faced with an inert film on one side. The inert side is the colored side of the septum. Place the colored side of the septum toward the sample solution.

- **Selecting Sample Vials.** Various sample vials are available from a number of sources. However, the vials you use with the AutoSampler must have the same external dimensions as the vials available from Varian (see Section 15, **8200 CX Parts and Supplies**).

The volume of sample available is likely the primary consideration when deciding on the appropriate sample vial. When the sample volume is very limited, use vials with very low volume, such as machined glass conical vials (80-100 μ L), or disposable microvial inserts with screw caps or crimp top closures (minimum target diameter of 5 mm) that fit inside a standard 2-mL vial. Refer to the Varian Analytical Supplies Catalog for sample vials that best fit your application.

- **Installing Vial Septa.** The 2-mL vials (P/N 03-949835-00) are shipped complete with plastic screw caps and Teflon®-laminated silicone rubber septa. Always place the colored, chemically inert Teflon laminate face down (next to the contents of the vial).

- **Changing Vial Septa.** The plain glass vial with cap and septum are inexpensive and are often discarded after analysis. You will not need to replace the septa for these vials. The machined glass microvials, however, are relatively expensive and you may want to reuse these vials with new septa (P/N 69-000169-00, 1 gross lot).

Section 5

SPME Injection Setup

To set up the 8200 CX AutoSampler prior to using the SPME Injection Method, you will

- Build a SPME Injection Method
- Install the fiber holder on the syringe carriage.
- Align the fiber with the injector port.
- Adjust the vial retainer arm if you will be using the 12-vial carousel.

None of these individual tasks should take you more than five minutes to complete.

BUILD A NEW SPME INJECTION METHOD

NOTE: Be sure you have selected the **SPME Device Setting in the 8200 Hardware Configuration window** (see **Section 2**, Specify the 8200 Hardware Configuration).

The method is a record of all the instructions and parameters required to analyze your sample. The Star Chromatography Workstation allows you to create separate methods for each of your sample types.

To build a new SPME Injection Method, proceed as follows:

1. Double-click on the “Method Editor” icon in the Varian Star group of the Program Manager.

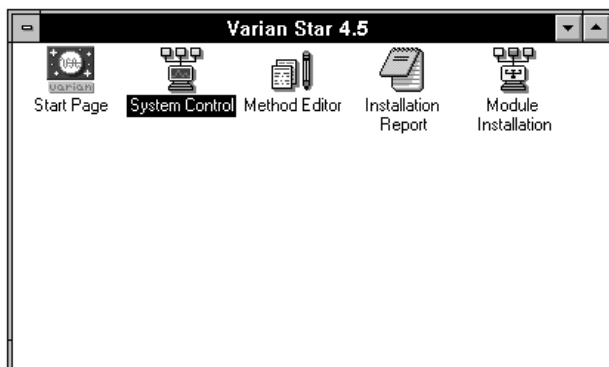

The Method Editor window appears with the Create/Open Method File in the foreground.

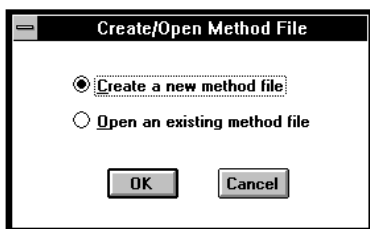

2. Select “Create a new method file” and click **OK**.
3. The New Method Section window appears. Select “8200 Stand-Alone AutoSampler” in the Instrument Control section of the window.

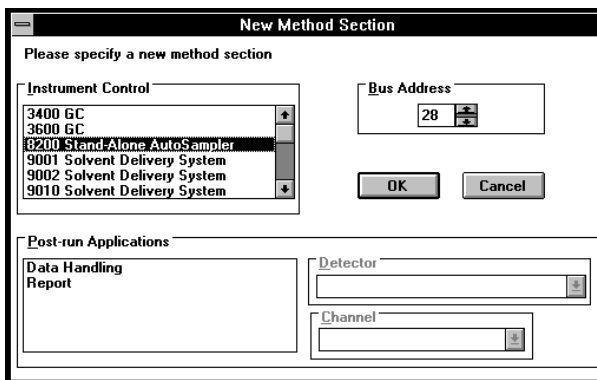

4. Referring to the following table, use the up and down arrows to set the Bus Address in the New Method Section window. Click **OK**.

If you have connected the 8200 Serial Cable¹ to the computer COM port labeled...	Set the Bus Address to...
COM1	24
COM2	28
COM3	32
COM4	36

¹See Page 22, **Connecting the Serial Cable to a PC or Varian Workstation**.

5. The New Method Section window closes and the 8200 Configuration icon appears in the lower left hand corner of the Method Editor window.
6. Double-click on the 8200 Configuration icon. The Configuration window appears.

SPECIFY THE CONFIGURATION WINDOW OPTIONS

1. Select the SPME Mode option under Sampling Modes in the Configuration window.

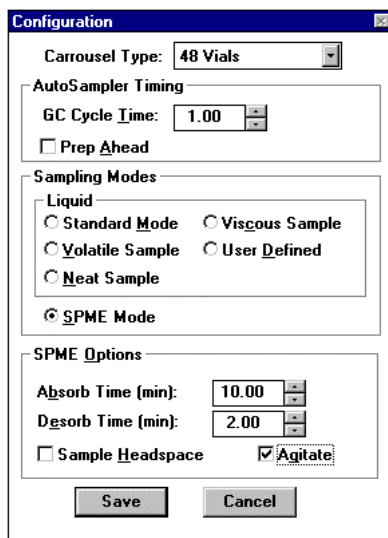

The screenshot shows the Configuration window with the following settings:

- Carousel Type: 48 Vials
- AutoSampler Timing: GC Cycle Time: 1.00, Prep Ahead:
- Sampling Modes: Liquid (Standard Mode, Viscous Sample, Volatile Sample, Neat Sample), SPME Mode
- SPME Options: Absorb Time (min): 10.00, Desorb Time (min): 2.00, Sample Headspace: , Agitate:

Buttons: Save, Cancel

NOTE: The SPME III Agitation option is an accessory option which provides for agitation of the sample during absorption time, thereby increasing the rate at which solutes are extracted by the SPME fiber coating. See Section 7 for operation with SPME agitation.

1. Set the Carousel Type to 48 Vials or 12 Vials using the pull-down menu that appears when you click on the arrow to the right of the box. The default value is 48 Vials.
2. Determine the length of a GC cycle (run time plus cooldown plus re-equilibration) by allowing the GC to cycle two or three times.
3. Under AutoSampler Timing, set the GC Cycle Time by entering the time in minutes.

4. Select Prep Ahead. Use of this feature is highly recommended with SPME to minimize dead time between runs. It allows absorption onto the SPME fiber of a sample while the previous sample is undergoing a chromatographic run.
5. Under SPME Options, set the Absorb Time in minutes.
6. Under SPME Options, set the Desorb Time in minutes.
7. If you are going to use the SPME Injection Method to sample headspace, check Sample Headspace by clicking on the box.
8. Click on **Save**. The Configuration window closes.

SAVE YOUR METHOD

1. Double-click on the Control menu box of the Method Editor. A window appears that asks you whether you want to save the changes you have made to the method.
2. Click **Yes**. The Save Method File As window appears prompting you to name the new method.

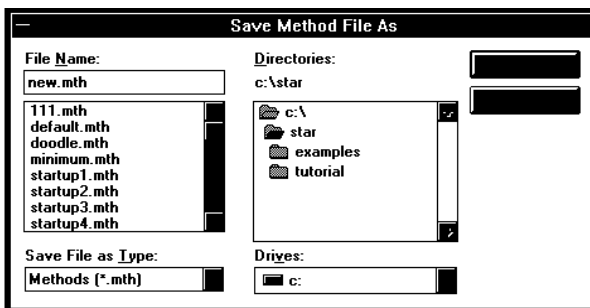

3. Assign a name of up to eight letters and/or numbers to the method, and click **OK**. The .mth extension will be added automatically.

INSTALL THE FIBER HOLDER ON THE SYRINGE CARRIAGE

To install the fiber holder on the syringe carriage, proceed as follows:

1. Remove the backing from the adhesive part of the AutoSampler's solvent line clamp (P/N 22-120202-00) and press the clamp into place (one-inch directly above the solvent line hole on the carriage).

- Open the front door of the syringe mounting assembly by *simultaneously* and firmly lifting *both* side locking tabs. Raise the tabs to the upper position. This may require considerable force, so hold the carriage assembly down with one hand. Alternatively, you may hold the mount down with both thumbs while you lift the tabs. The locking mechanism will become less stiff with use. A red tab is visible above the syringe mount assembly when the door is unlocked.
- Remove the liquid syringe and place the solvent line in the solvent line clamp.



**WARNING:
EYE HAZARD**

Wear Proper Eye Protection. Solvent may spray out of the Teflon® tubing when disconnected from the syringe.

- Place the fiber into the fiber holder according to the installation procedures supplied with Supelco™ SPME fiber and fiber holder. Refer to the following diagrams.

SPME Holder with Fiber Assembly

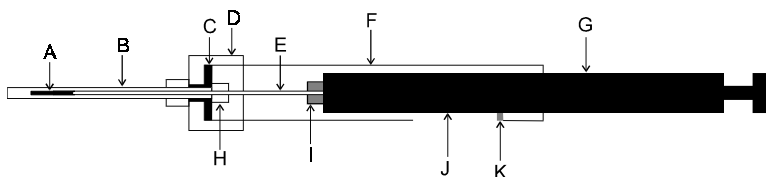

Fiber Assembly

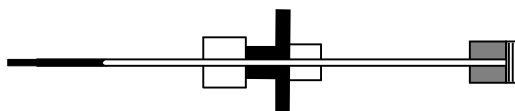

- A SPME Fiber
- B Septum Piercing Needle
- C Needle Ferrule
- D Retaining Nut
- E Fiber Attachment Needle
- F Barrel
- G Plunger
- H Sealing Septum
- I Color-Coded Screw Hub
- J Slot
- K Retaining Screw

NOTE: If a fiber is already installed in the fiber holder, make sure that the plunger is withdrawn so that the fiber is completely inside the septum piercing needle before disassembling any part of the SPME holder.

5. Install the fiber assembly in the AutoSampler syringe mount.

NOTE: If the agitation accessory is installed, see Section 7 for details on fiber holder installation.

NOTE: If, after you have installed the fiber assembly, the fiber extends from the sheath, do not proceed with the fiber alignment until you have first activated your SPME injection method. To do this, follow the steps given on Page 125, Activate a Method, using the method you created in Build a New SPME Injection Method, Page 77. This will cause the fiber to retract into the sheath even if you have not yet completed the remaining steps in this SPME injection method setup.

6. Close the syringe mount door.

- Check that the door is fully closed before pushing the side-locking tabs down. Then, holding the door closed and supporting the carriage with one hand, press the side locking tabs down with the other hand. This locks the syringe into position so that the syringe hex screw does not move. When the tabs are down, the door is locked and the red signal tab is not visible.

ALIGN THE FIBER WITH THE INJECTOR PORT

When you initially install the fiber in the syringe mount, the alignment of the fiber with the needle port of the injector nut may not be precise.

NOTE: Once the fiber is correctly mounted, you will not need to adjust it again.

To align the fiber with the injector port, proceed as follows:

NOTE: Be sure that the injector insert is compatible with the SPME injection technique, i.e., do not use a packed insert or high performance SPI insert.

NOTE: The GC should be cooled down during this operation.

1. Check that the AutoSampler power switch is OFF. The power switch is located on the rear of the tower.

2. Press down on the storage module latch release and swing the module out to access the GC injector. When the storage module swung out (with power off), a contact in the latch assembly activates that turns the syringe carriage stop solenoid on or off each time the carriage position sensor is interrupted.

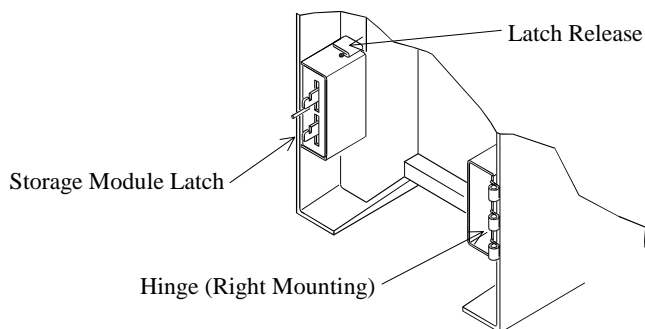

NOTE: You must press the latch release down when relatching the storage module.

3. Wearing gloves to prevent contamination, remove the injector nut and replace the glass insert in the injector, as described in your injector manual.
4. Replace the injector nut, and verify that the column head pressure is adequate.
5. Turn the GC power ON.
6. Turn the AutoSampler power ON.
7. Raise the syringe carriage from its rest position to its top limit. The stop solenoid toggles (you will hear a “click”) to allow you to lower the carriage by hand.

CAUTION

Take care that the carriage does not drop and damage the fiber assembly.

8. Loosen the screws holding the mounting plates in place so that the AutoSampler can be moved on the GC cover.
9. Lower the syringe carriage by hand until the fiber/sheath tip is just above the GC injector needle port.
10. Carefully adjust the position of the AutoSampler to bring the fiber/sheath tip into precise alignment with the injector needle port.

11. Securely tighten the screws holding the mounting plates in place.
12. Lower the syringe carriage and puncture the injector septum three or four times with the fiber sheath to ensure that the fiber is properly aligned with the injector port.
 - Repeat this procedure each time you replace the injector septum.
13. To return the syringe carriage to its rest position, raise the syringe carriage to its upper limit of travel. Then lower the carriage a fraction of an inch until it engages.
14. Close the storage module.

NOTE: To re-latch the storage module, the latch release must be pressed down.

ADJUST THE VIAL RETAINER ARM HEIGHT

To adjust the vial retainer arm height, proceed as follows.

1. Locate the vial retainer arm on the AutoSampler.

- A Solvent Line
- B Plunger Drive
- C Carriage
- D Side Locking Tabs
(2 places)
- E Syringe Mount
- F Carriage Bracket
- G Needle Guide
- H Vial Retainer Arm

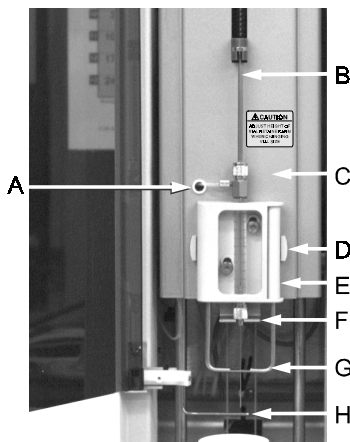

NOTE: Be sure this label is placed in full view on lower portion of carriage.

- Using a 0.05-inch hex wrench, loosen the hex screw that holds the vial retainer arm in position.
- Slide the vial retainer arm up or down to the stop clip to accommodate 10-mL or 2-mL vials, respectively. Check that vial clears retainer arm and readjust for slight clearance.
- Tighten the hex screw.
- Check arm alignment on Page 34.

- A Vial Retainer Arm Block
- B Hex Screw
- C 10 mL Vials (adjust up)
2 mL Vials (adjust down)
- D Vial Retainer Arm

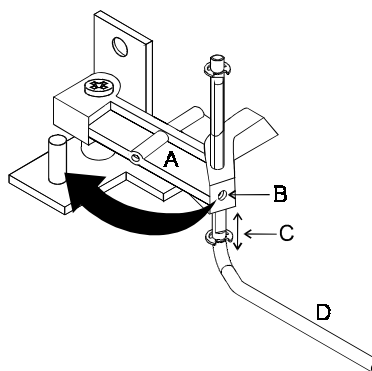

FINAL SPME INJECTION METHOD SETUP CHECKLIST

Setup of the SPME Injection Method for your 8200 CX AutoSampler is now complete. Before operating the AutoSampler as described in Section 6, make sure you have

- Built a SPME Instrument Control Method
- Installed the fiber on the syringe carriage
- Aligned the fiber with the injector port
- Adjusted the vial retainer arm for the size of vial you will use
- Installed a SPME compatible injector insert

Section 6

SPME Injection Operation

This section gives additional information that you will need to operate the 8200 CX AutoSampler using the SPME Injection Method. After familiarizing yourself with the information in this section, proceed directly to Section 11, **Performing Injections**.

SAMPLING

LOADING THE CARROUSEL

The carousel rotates clockwise and the vial position numbers increase counter-clockwise around the carousel. Observe this order when loading sample vials. Load sample vials according to the vial numbers shown on the carousel label.

The AutoSampler ignores vials without a septum. Seal all vials in the carousel that are to be sampled with a cap and septum.

SAMPLE VIALS

The 48-vial carousel takes a standard 2-mL glass Screw Top vial with outside dimensions of 12 x 32 mm (12 x 35 mm with cap). The vial is sealed with a plastic screw cap with a 5-mm hole, and a white silicone rubber septum (8-mm diameter) faced with an inert film on one side. The inert side is the colored side of the septum. Place the colored side of the septum toward the sample solution.

NOTE: **The 48-vial tray can be placed on the turntable in any position.**

The 12-vial carousel takes a standard 10-mL glass Crimp Top vial with outside dimensions of 25 x 50 mm (25 x 54 mm with cap). The vial is sealed with a crimp top cap with a 9.5-mm hole, a Viton® septum, and a silicone-rubber o-ring. It is recommended that you place the o-ring in contact with the crimp top, and the Viton® septa between the o-ring and the top of the vial.

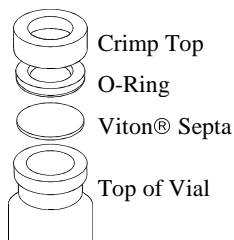

NOTE: Other vials compatible with the Varian 8200 12-vial tray will become available later. Check with your Varian representative for availability.

NOTE: The 12-vial tray must be placed on the turntable with the pin aligned with vial 1.

- **Selecting Sample Vials.** The vials you use with the AutoSampler must have the same external dimensions as the vials available from Varian (see AutoSampler Parts and Supplies).

The volume of sample available is likely the primary consideration when deciding on the appropriate sample vial. When the sample volume is very limited, use vials with very low volume, such as machined glass conical vials (80-100 μL), or disposable microvial inserts with screw caps or crimp top closures (minimum target diameter of 5 mm) that fit in a standard 2-mL vial. Refer to the Varian Analytical Supplies Catalog for sample vials that best fit your application.

- **Installing Vial Septa.** The 2-mL vials (P/N 03-949835-00) are shipped complete with plastic screw caps and Teflon®-laminated silicone rubber septa. Always place the colored, chemically inert Teflon laminate face down (next to the contents of the vial).

The 10-mL vials (P/N 03-918873-02) are shipped with crimp top caps with black Viton® septa inserted. Remove the black Viton septum; place the o-ring in the cap, then replace the thin Viton septum. Place the cap on the vial.

NOTE: To ensure that the SPME fiber experiences a long lifetime, use only septa supplied by Varian.

CONDITIONING THE FIBER

A new fiber must be conditioned by desorbing it for a minimum of 15-20 minutes in an injector that is at least 10°C warmer than the temperature to be used during the analysis. The GC column should then be temperature programmed. This procedure should be repeated until there are no extraneous peaks.

SAMPLE VOLUMES

- **Liquid Sampling.** Fill the 2-mL vials with no more than 1.2 mL of liquid.
Fill the 10-mL vials with exactly 10 mL of liquid. These vials actually hold 16 mL, so a large air space remains over a 10-mL sample.
- **Headspace Sampling.** Fill the 2-mL vials with no more than 0.8 mL of sample.
Fill the 10-mL vials (they actually hold 16 mL) with no more than 10 mL of sample.

SETTING THE SPME/GC PARAMETERS

- **Injector Temperature.** The injector temperature should be the lower of the following: 20°C below the column limit and the SPME fiber temperature maximum. One to two minutes is usually sufficient for desorption, but this value varies with fiber and sample type.
- The recommended injector inserts for SPME are shown below:

Injector	Insert	Part Number
Varian SPI (1093,1094)	SPI SPME insert	03-918332-05
1078	1078 SPME Insert	03-925330-00
1075/1078	2 mm ID Splitless	03-949437-90

RUNNING THE TEST SAMPLE

After installing the SPME software, hardware, and fiber, test the SPME system with the **SPME Sensitivity Test Sample**.

GC Conditions

To run the SPME Sensitivity Test Sample, use the following GC conditions:

Column:	Nearly any capillary column can be used to separate the SPME Sensitivity Test Sample.
Column Conditions:	50°C for 1 minute; then 20°C/minute to 150°C; hold for 2 minutes.
Injector:	200°C isothermal.
Detector:	Settings depend on the detector used.

SPME Software Settings

Adsorb Time: 10 minutes

Desorb Time: 1 minute

SPME CONDITIONS

Fiber: 100 µm PDMS

Glass Insert: SPI/SPME

Carrier Gas: 4.7 mL/min

The test sample is composed of 1 ng/µL each of nitrobenzene and nitrotoluene in water (1% methanol has been added to stabilize the sample). These compounds were selected because they exhibit a good response with many GC detectors, including the flame ionization detector, the electron capture detector, the thermionic selective detector, and the ion trap detector.

A representative SPME test sample chromatogram is shown.

GC CONDITIONS

Injector: 200°C
Column: 50°C/min, hold 1 min
Program: 20°C to 110°C, hold 2 min
Detector: 240°C

The chromatogram shown was obtained with an FID:
range 10, attenuation 128.

- 1 Nitrobenzene
- 2 Nitrotoluene

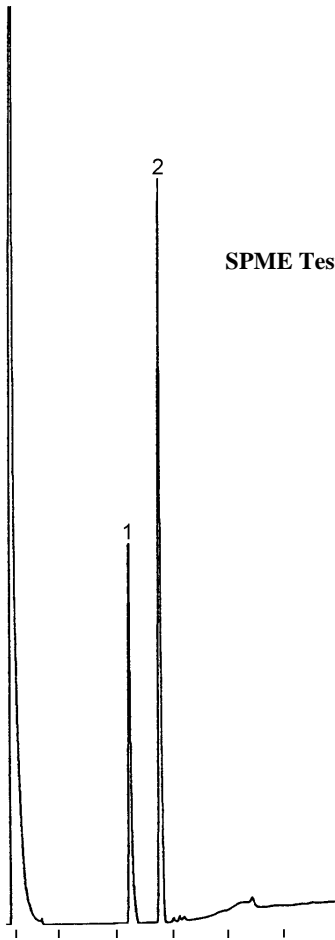

SPME Test Sample Chromatogram

Section 7

SPME III with Agitation

INTRODUCTION

Solid Phase MicroExtraction (SPME) may be used for extraction and concentration of both volatiles and semi-volatile components. Typically, extraction of volatiles is performed with the SPME fiber inserted into the headspace of the sample. Because of the high diffusion rates of volatiles in the gas phase, no agitation of the sample is usually required to achieve good results in a reasonable amount of time.

Semi-volatile components must be extracted with the fiber inserted into the bulk sample. In this case, sampling times can be quite long before equilibrium occurs of the sample with the fiber coating. The higher the molecular weight of the sample, the lower the diffusion rate, and the longer time that is required for sample uptake by the fiber.

If the sample is well-mixed during the SPME process, then diffusion rates in the liquid sample are no longer a factor in sampling time. For this reason, an agitation accessory was developed as an option for the Varian 8200 AutoSampler. The increase in uptake rate for a specific compound, fluoranthene, can be seen below.

Comparison of Fluoranthene Uptake With and Without Agitation

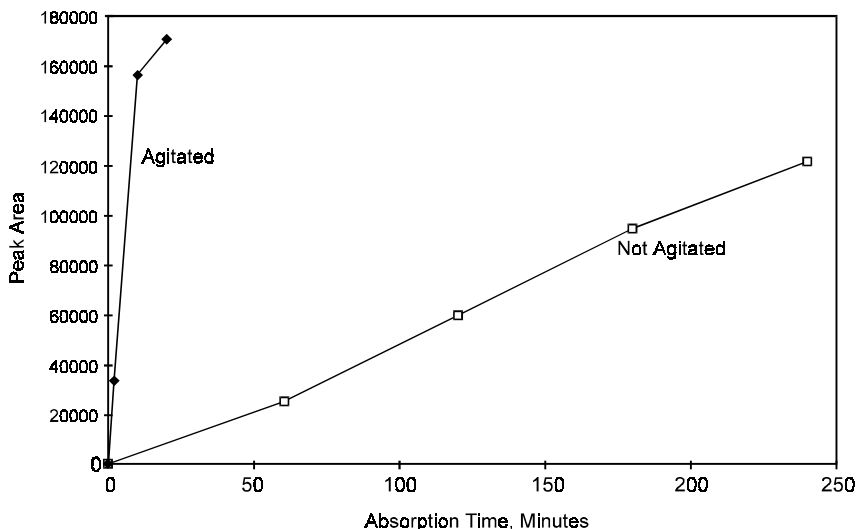

OPERATION OF THE SPME AGITATION ACCESSORY

PRINCIPLES OF OPERATION

The SPME agitation accessory for the Varian 8200 AutoSampler is used during automated Solid Phase MicroExtraction (SPME) of liquid samples. This device provides for agitation of the sample during extraction, thereby increasing the rate at which solutes are absorbed by the SPME fiber coating. Agitation of the sample during SPME allows the solutes to reach equilibrium with the fiber much more rapidly than when the sample is not agitated.

The SPME agitation accessory works by vibrating the SPME fiber protective sheath. Vibration of the sheath results in vibration of the fiber in the liquid sample, thereby causing the fiber to contact fresh (undepleted) sample continuously.

This mechanism of agitation gives better results than either ultrasonic vibration or magnetic stirring using a Teflon®-coated stirbar. Ultrasonic vibration gives efficient mixing, but heats the sample. Magnetic stirbars do not provide the agitation required to mix the liquid layer near the fiber with the rest of the bulk solution.

DESCRIPTION OF THE AGITATION DEVICE

The SPME agitation accessory consists of a small precision motor which drives a small eccentric wheel (cam). The cam is coupled to a rigid arm, which vibrates back and forth when the cam is spinning. This vibration is transferred to the SPME fiber sheath through a silicone rubber septum, which is mounted in the rigid arm. The fiber sheath passes through the center of this septum.

The septum provides a degree of damping to the vibration, so that the sheath is never forced to move far enough to damage either the sheath or the fiber. The amplitude of vibration and the speed of rotation of the motor have been carefully chosen to provide optimum results, and cannot be changed.

The following picture shows the SPME agitation accessory. The agitation system is mounted on the AutoSampler carriage to the right of the syringe mount. Power is supplied to the motor by a cable attached to the motor with a slip-on connector. The entire mechanism is held onto the mounting plate with three screws, which can be loosened for easy removal of the entire agitation mechanism.

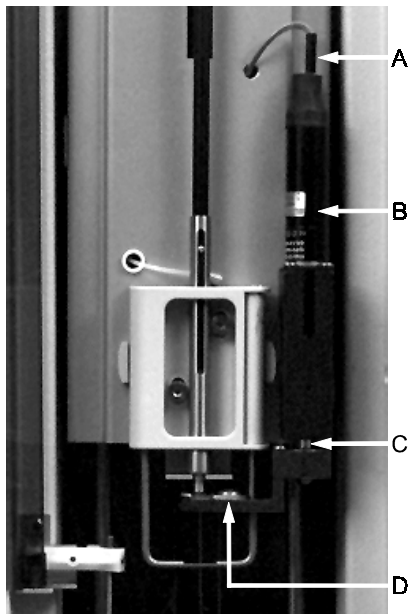

- A Power Connector
- B Agitation Motor
- C Cam
- D Septum Holder

INSTALLATION

The SPME III agitation accessory is factory installed. Field upgrades of the agitation accessory may be performed on 8200 AutoSamplers purchased after June 1996.

Installation of the AutoSampler should proceed exactly as described in Section 2 of this manual.

If the 48-vial carousel is to be used, no further modifications are necessary. If the 12-vial carousel is to be used, the AutoSampler must be modified as follows:

1. Change the position of the vial retainer arm to its uppermost setting (see Section 5, Page 84).
2. Attach the vial retainer arm activator strip to the front, left hand side of the AutoSampler carriage. This strip clips under the carriage at its lower end and is held onto the carriage with a single screw.

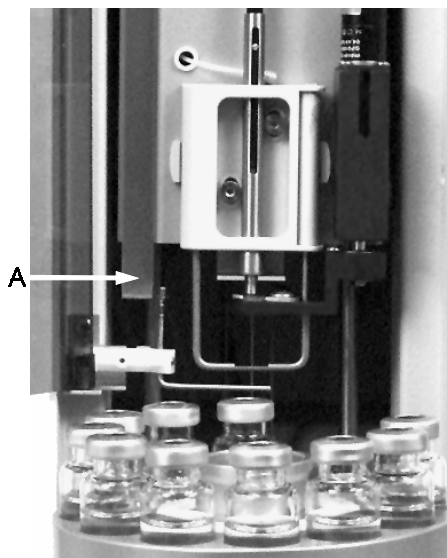
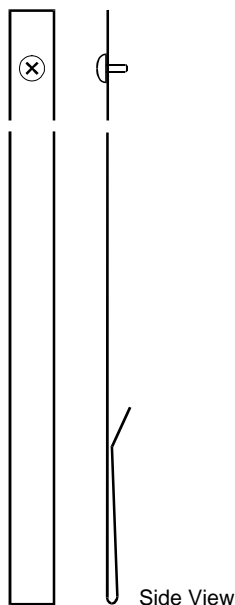

A Activator Strip

SETUP AND OPERATION

The following procedure must be followed to set up the SPME agitation accessory for sampling and injections:

1. Install a pre-drilled septum into the rigid agitator arm, if one has not already been installed.
2. Install the SPME fiber holder with fiber assembly into the 8200 syringe holder, making certain that the fiber sheath is inserted through the center of the septum in the agitator arm and the needle guide of the syringe holder.
3. Build a method for SPME sampling with the **Agitate** box checked.

SPME sampling will then occur with vibration of the fiber from the time the fiber is extended from the sheath into the sample to the time just before the fiber is withdrawn back into the sheath. Details of the above procedure are given:

INSTALLATION OF AGITATOR SEPTUM

To install a new agitator septum, first remove the SPME fiber holder, if one is installed. Loosen the Phillips head screw holding the septum retainer to the rigid arm. Rotate the retainer enough so that the old septum may be removed, and insert a new pre-drilled septum. Rotate the septum retainer back to its original position and tighten the retaining screw.

NOTE: If a pre-drilled septum is not available, prepare a new septum by pushing an old fiber sheath or similarly sized needle through the center of the septum to create a guide hole. It is very important to locate the center of the septum in this manner before installing the new septum into the rigid arm.

INSTALLATION OF SPME FIBER HOLDER

Open the syringe mounting assembly by lifting the side locking tabs (see Section 5 for details of this operation). Because of the limited access to the right-hand tab, it may be necessary to use a tool, such as a flat-blade screwdriver, to facilitate this operation. Remove the liquid sampling syringe, if one is installed, and clip the solvent line into the solvent line clamp. After first making certain that the fiber is completely withdrawn into the fiber sheath, insert the sheath through the hole in the center of the pre-drilled septum.

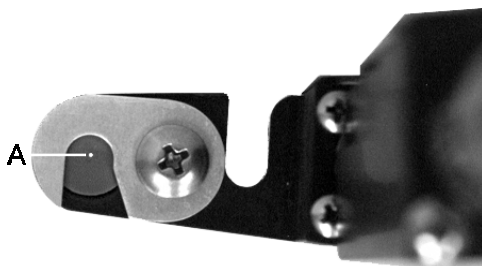

A Pre-drilled Septum Hole

Carefully guide the fiber sheath through the lower needle guide while moving the entire holder assembly into the syringe mounting assembly. Ensure that the end of the plunger is inserted into its guide. Close and lock the syringe mount door.

BUILDING A METHOD THAT INCLUDES AGITATION

Refer to Section 5 for details on building a SPME method. To activate agitation, open the Method Editor for the 8200 Stand-Alone AutoSampler Module. In the SPME Options area of the Configuration window a check box labeled **Agitate** will be found. This box must be checked to activate agitation of samples during SPME operation.

The screenshot shows the 'Configuration' dialog box with the following settings:

- Carrousel Type: 48 Vials
- AutoSampler Timing
 - GC Cycle Time: 1.00
 - Prep Ahead:
- Sampling Modes
 - Liquid
 - Standard Mode:
 - Viscous Sample:
 - Volatile Sample:
 - User Defined:
 - Neat Sample:
 - SPME Mode:
- SPME Options
 - Absorb Time (min): 10.00
 - Desorb Time (min): 2.00
 - Sample Headspace:
 - Agitate:

Buttons: Save, Cancel

CHANGING FROM SPME III TO LIQUID SAMPLING

Liquid sampling with the standard 10 μ L syringe (or static headspace or LVI sampling) requires removal of the agitation accessory. Use the following procedure to remove the accessory:

1. Open the syringe holder and remove the SPME fiber holder. Close and lock the syringe holder.
2. Unplug the power cable from the top of the motor.

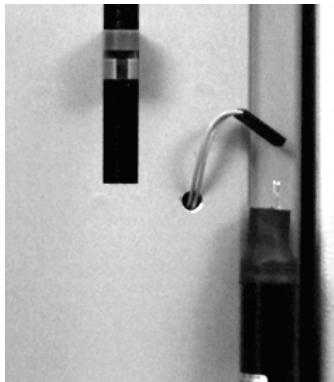

3. Using a small Phillips head screwdriver, insert screwdriver in the hole in the side of the tower casting. Loosen this screw a couple of turns.



4. Unlatch the carousel module and swing the module away from the AutoSampler tower. Turn the AutoSampler power off, then back on. Lift the AutoSampler carriage upward until an audible click can be heard. The latch that prevents the carriage from dropping has now been pulled back, and the carriage can be lowered to any position.

5. Lower the carriage until the top screw is aligned with the hole in the side of the tower casting. Loosen this screw a couple of turns.



6. Raise the carriage and loosen the bottom screw.
7. The agitation assembly may now be removed from the mounting bracket by pulling straight out.



8. If the 12-vial carousel has been in use, remove the vial retainer arm activator strip and reset the vial retainer arm to its lowest position.

Converting to SPME sampling from liquid sampling is the reverse of the above procedure.

TROUBLESHOOTING AND MAINTENANCE

The SPME agitation accessory has been designed so that it needs little or no maintenance during routine operation, other than changing the agitator damping septum regularly. It is recommended that the septum be replaced at least once every 100 injections. The septum should also be replaced if it begins to look worn or fragmented.

If the agitator does not function when it should, first check your method for proper setup. Remember, the **Agitate** box must be checked and the Method must be active for agitation to occur. If the agitator still does not work, check all cables and electrical connections. If the motor still does not run, then a qualified Varian Customer Support Representative must investigate the problem.

METHOD DEVELOPMENT HINTS

Agitation of the sample during Solid Phase MicroExtraction increases the rate of absorption of analytes by the fiber. Agitation does not increase the total amount of analyte absorbed at equilibrium. In many cases, it is not necessary to reach equilibrium to achieve good analytical results. If the sampling time is consistent from one sample to the next, reasonable peak area reproducibility can be obtained. This should be considered for analytes that take a long time to reach equilibrium with the fiber, even with agitation.

In general, the higher the molecular weight of a solute, the longer it will take to reach equilibrium with the fiber, due to slower diffusion rates into the fiber. The type of fiber chosen will also affect time to equilibrium.

Methods development for a SPME method incorporating agitation primarily requires determination of the sampling time which is sufficient to provide adequate detection limits for solutes with reasonable reproducibility. Since SPME is a sample preparation technique, and not a direct injection of a sample solution, reproducibilities should be comparable or better than other sample preparation techniques, such as solid phase extraction and Soxhlet extraction.

Reproducibilities for such methods are typically in the range of 5% to 25% RSD (relative standard deviation).

Automated methods development can be performed with the 8200 to determine optimum absorption and desorption times by setting up several methods containing the different parameters. These methods can then be run in sequence, and the results analyzed to determine the best parameters.

Because SPME is a competitive equilibrium technique, usually with aqueous samples, poor reproducibilities may result from interactions not encountered in samples dissolved in organic solvents. For example, the glass walls of vials may adsorb components from the sample, introducing error. It may be necessary to add a displacing agent, such as acid, to the sample to eliminate this effect. Keep in mind that SPME samples through chemical interactions, rather than pure physical measurements, when developing methods for your analytes.

Section 8

Ambient Headspace Injection Setup

To set up the 8200 CX AutoSampler prior to using Ambient Headspace, you will

- Build the Ambient Headspace Injection Method
- Remove any solvent from the solvent lines
- Connect the pneumatics
- Install the 100- μ L headspace syringe
- Align the syringe needle with the injector port

With the exception of removing the solvent from the solvent lines, which may take 15 minutes or longer, none of these tasks should take you more than 5 minutes to complete.

NOTE: Ambient Headspace Sampling requires removal of the SPME agitation accessory. If this device is installed on your AutoSampler, refer to Section 7, Changing From SPME III to Liquid Sampling on Page 98.

BUILD THE AMBIENT HEADSPACE INJECTION METHOD

The method is a record of all the instructions and parameters required to analyze your sample. The Star Chromatography Workstation allows you to create separate methods for each of your sample types.

NOTE: Be sure you have selected the 100 μ L Syringe Setting. See Specify the 8200 Hardware Configuration on Page 39.

To build a new ambient headspace injection method, proceed as follows:

1. Double-click on the “Method Editor” icon in the Varian Star group of the Program Manager.

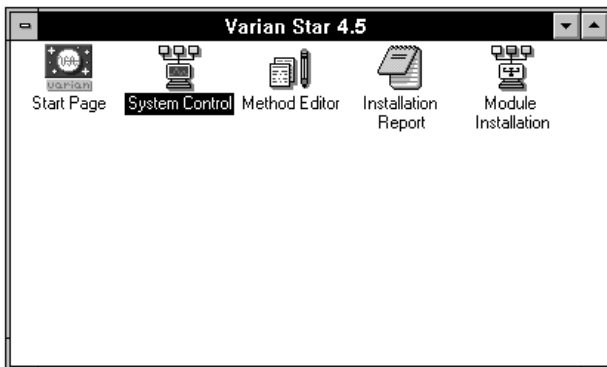

The Method Editor window appears with the Create/Open Method File in the foreground.

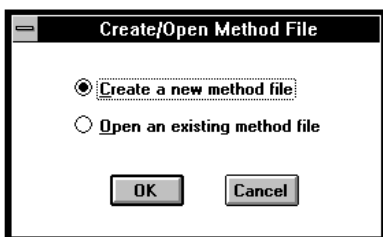

2. Select “Create a new method file” and click **OK**.
3. The New Method Section window appears. Select “8200 Stand-Alone AutoSampler” in the Instrument Control section of the window.

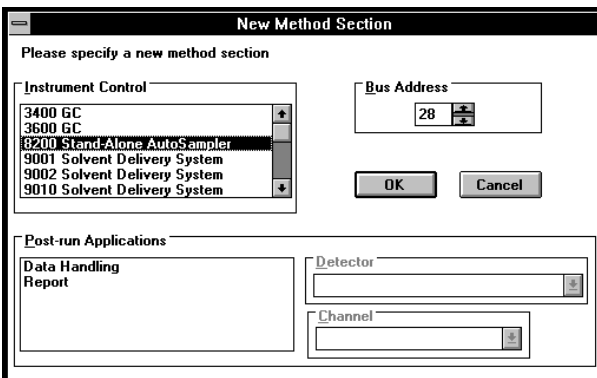

4. Referring to the following table, use the up and down arrows to set the Bus Address in the New Method Section window. Click **OK**.

If you have connected the 8200 Serial Cable ¹ to the computer COM port labeled...	Set the Bus Address to...
COM1	24
COM2	28
COM3	32
COM4	36

- The New Method Section window closes and the 8200 Configuration icon appears in the lower left hand corner of the Method Editor window.
- Double-click on the 8200 Configuration icon. The Configuration window appears.

SPECIFY THE CONFIGURATION WINDOW OPTIONS

- Select the User Defined option under Liquid in the Sampling Modes section of the Configuration window.

The screenshot shows the Configuration window with the following settings:

- Carrousel Type:** 48 Vials
- AutoSampler Timing:** EndTime: 1.00, Prep Ahead:
- Sampling Modes:** Liquid: Standard Mode, Viscous Sample, Volatile Sample, User Defined, Neat Sample, SPME Mode
- Liquid Sampling Options:** Solvent A Wash: [dropdown], 100 uL Syringe: [dropdown]
- User Defined Parameters:**
 - Solvent Elush Sampling: Yes, No
 - Syringe Wash Time (sec): 20
 - Air Dry After Wash: Yes, No
 - Solvent Plug Size (ul): 10
 - Vial Ngeedle Depth (%): 90
 - Uptake Speed (ul/sec): 50
 - Upper Air Gap: Yes, No
 - Lower Air Gap: Yes, No
 - Pause Time (sec): 2
 - Hot Needle Time (min): 0.00
 - Injection Rate (ul/sec): 50
 - Needle Residence Time (min): 0.00

- Set the Carrousel Type to 48 Vials using the pull-down menu that appears when you click on the arrow to the right of the box.
- Under AutoSampler Timing, set the End Time using the up and down arrows.
- The Prep Ahead option should be deselected for Ambient Headspace injections.

¹See **Connecting the Serial Cable to a PC or Varian Workstation** on Page 22.

5. Under Liquid Sampling Options, set the top selection to “Solvent A Wash” if the solvent A reservoir contains only air, to “Solvent B Wash” if the solvent B reservoir contains only air, or to “A then B” if both reservoirs contain only air. You select this option using the pull-down menu to the right of the box.
6. Under Liquid Sampling Options, set the bottom selection to “100 μ L Syringe” using the pull-down menu that appears when you click on the arrow to the right of the box.
7. Under User Defined Parameters, select “Yes” for Solvent Flush Sampling.
8. Under User Defined Parameters, set Syringe Wash Time (sec) using the up and down arrows.
9. Under User Defined Parameters, select “No” for Air Dry After Wash.
10. Under User Defined Parameters, set the Vial Needle Depth by clicking on the arrows to change the default value of 90%. You should set the vial needle depth so that the needle does not penetrate the liquid in the sample vile. For a volume of 1 mL, a vial needle depth of 25% is reasonable.
11. Under User Defined Parameters, set the Uptake Speed (μ L/sec) using the up and down arrows.
12. Under User Defined Parameters, set the Pause Time (sec) using the up and down arrows.
13. Under User Defined Parameters, set the Hot Needle Time (sec) using the up and down arrows.
14. Under User Defined Parameters, set the Injection Rate (μ L/sec) using the up and down arrows.
15. Under User Defined Parameters, set the Needle Residence Time (min) using the up and down arrows.
16. Click on Save. The Configuration window closes.

SAVE YOUR METHOD

1. Double-click on the Control menu box of the Method Editor. A window appears that asks you whether you want to save the changes you have made to the method.

Click **Yes**. The Save Method File As window appears prompting you to name the new method.

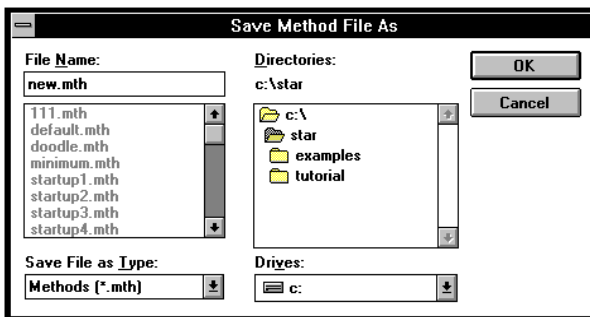

2. Assign a name of up to eight letters and/or numbers to the method, and click **OK**. The .mth extension will be added automatically.

If...	Then....
this is a new AutoSampler installation	Proceed to Connect the Pneumatics , Page 108.
you have been using your AutoSampler for Liquid Injection (and have therefore already connected the pneumatics)	Proceed to Remove Solvent from the Solvent Lines , Page 109.

CONNECT THE PNEUMATICS

The 8200 CX AutoSampler requires clean, chromatographically pure compressed (40 to 60 psig) air or nitrogen to operate using Ambient Headspace Injection. A chromatographic grade gas is recommended.

To connect the pneumatics, follow this procedure:

1. Connect the supply cylinder to the “barbed” fitting on the rear panel of the AutoSampler using the 1/8-inch OD polyurethane tubing from the Standard Accessory Kit. The barbed fitting is labeled GAS INLET 40-60 psig.

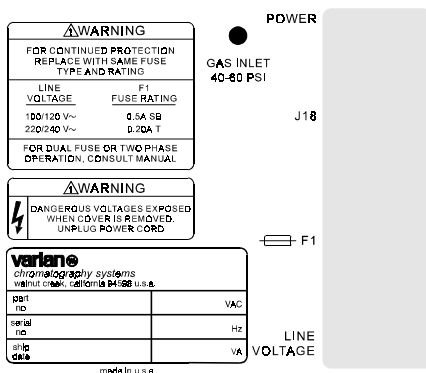

2. To make the connection at the GAS INLET, press the 1/8-inch OD tubing onto the barbed hose connector. Tug firmly on the tubing to make sure it is fully gripped on the fitting, referring to the diagram below.



WARNING: EYE HAZARD

Wear Proper Eye Protection. To prevent possible injury from a flailing gas line, shut off the gas supply valve before disconnecting the line.

NOTE: The pressure regulator has been preset at the factory to 20 psi.

3. Proceed to Page 110, Install the 100- μ L Syringe Assembly.

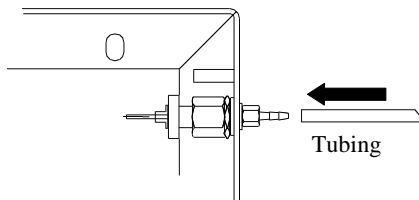

REMOVE SOLVENT FROM THE SOLVENT LINES

During the headspace sampling sequence of the 8200 CX AutoSampler, the solvent lines and syringe are flushed with air to minimize the carryover of sample between runs. Therefore, at least one of the solvent reservoirs must contain only air. If the unused solvent reservoir contains a solvent to which the detector to be used in the headspace analysis responds, make certain that you have removed all traces of this solvent, otherwise the solvent will interfere with the headspace analysis.

NOTE: You do not need to clear the solvent lines if the AutoSampler has not been used since it was shipped from the factory.

To remove solvent from the Teflon® solvent lines, proceed as follows:

1. Remove the solvent reservoir(s) that contain wash solvent from the AutoSampler.
2. Remove the solvent filter, nut and the blue ferrule from the Teflon® tubing. Carefully wipe any solvent from the outside of the tubing and let the tubing dry.
3. Replace the solvent reservoir with either a new solvent reservoir (P/N 03-908877-00) or the current solvent reservoir after it has been thoroughly cleaned and dried. You do not need to install a solvent filter. If a solvent filter is installed, replace that filter with a new solvent filter (P/N 28-211512-00) that has never been immersed in solvent.
4. Install a clean septum (P/N 00-997628-01) in the waste cup of the AutoSampler.

FLUSH THE SOLVENT LINES

To flush the solvent lines, proceed as follows:

1. Follow the steps given on **How to Inject a Single Sample** on Page 125, using the method you created in **Save Your Method** on Page 107. This procedure will cause the pure air or nitrogen to flush through the solvent lines even if you have not yet completed the remaining steps in this Ambient Headspace injection method setup.
 - Pure air or nitrogen is flushed through the solvent lines.
2. Repeat Step 1 at least three times to thoroughly flush the solvent lines.

INSTALL THE 100- μ L SYRINGE ASSEMBLY

Once you have correctly mounted the syringe in the syringe bracket, you will not need to make further adjustments.

NOTE: Do not install the 100- μ L syringe in the AutoSampler unless the solvent lines are free of solvent. If you need to clear the solvent lines, refer to Remove Solvent from the Solvent Lines on Page 109.

To install the syringe/needle assembly (P/N 03-918728-00) in the syringe carriage, proceed as follows:

1. Place both thumbs on the side locking tabs on either side of the syringe bracket. Push up on the bracket until the red tab appears. Open the front door of the syringe mount assembly.
2. Guide the syringe needle into and through the small hole in the needle guide. Press the syringe nut into the slot such that the top of the nut rests on the upper surface of the syringe carriage bracket. Press the syringe plunger button into the slot of the lead screw nut.
3. Close the front door of the syringe mount assembly and press the side locking tabs down while supporting the carriage. The red signal tab is no longer visible. With the locking tabs down, the syringe is locked into position so any movement of the syringe hex nut will be minimal.
4. Connect the solvent line to the syringe side arm. Slide the knurled nut back from the end of the tubing. Press the tubing firmly against the machined shoulder of the side arm port. Slide the nut up to the port and snugly thread it onto the side port. Tighten the nut with your fingers only. Do not use pliers.

ALIGN THE SYRINGE NEEDLE WITH THE INJECTOR PORT

To align the 100- μ L syringe needle with the injection port, proceed as follows:

1. Make sure that the AutoSampler power switch is OFF. The power switch is located on the rear of the tower.
2. Press down on the storage module latch release and swing the module out to access the injector assembly. With the storage module swung out and AutoSampler power switch OFF, a contact in the latch assembly is activated that toggles the carriage stop solenoid on or off each time the carriage position sensor is interrupted.

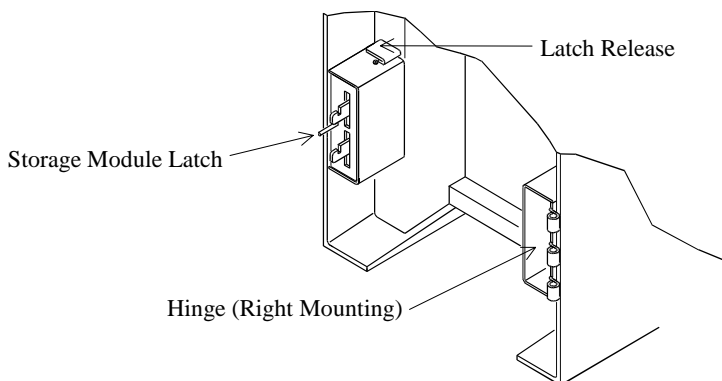

NOTE: To re-latch the Storage Module, the latch release must be pressed down.

3. Turn the GC power switch ON. Turn the AutoSampler power switch ON. Raise the syringe carriage from its rest position until you here a click. The stop solenoid toggles to permit you to lower the carriage by hand.

NOTE: As you align the syringe, take care to support the syringe carriage so that it does not drop and damage the syringe or needle assembly.

4. Loosen the screws holding the mounting plates in place so that you can move the AutoSampler on the GC cover. Lower the syringe carriage by hand until the needle tip is just above the GC injector needle port. Move the AutoSampler such that the syringe needle is precisely aligned with the injector needle port. Tighten the mounting plate screws securely.

5. Lower the syringe carriage two or three times so that the syringe needle punctures the injector septum. This ensures that the syringe and syringe needle are properly aligned with the injector port. Repeat this procedure each time you replace the injector septum.

NOTE: Once the mounting plate(s) have been aligned, they should not require further adjustment.

6. Raise the syringe carriage to its rest position (its upper limit of travel). Then, lower the syringe carriage a fraction of an inch so that it rests on the stop solenoid latch.
7. Close the storage module.

FINAL AMBIENT HEADSPACE SETUP CHECKLIST

Setup for Ambient Headspace Injection for your 8200 CX AutoSampler is now complete. Before operating the AutoSampler as described in Section 9, make sure you have

- Built the Ambient Headspace injection method
- Removed any solvent from the solvent lines
- Connected the pneumatics
- Installed the 100- μ L syringe
- Aligned the syringe needle with the injector port

Section 9

Ambient Headspace Injection Operation

This section gives additional information that you will need to operate the 8200 CX AutoSampler using the Ambient Headspace Injection Method. After familiarizing yourself with the information in this section, proceed directly to Section 11, **Performing Injections**.

NOTE: The Ambient Headspace Injection does not support liquid injection modes.

SAMPLING

LOADING THE CARROUSEL

The carousel rotates clockwise and the vial position numbers increase counterclockwise around the carousel. Observe this order when loading sample vials. Load sample vials according to the vial numbers shown on the carousel label.

The AutoSampler ignores vials without a septum. Seal all vials in the carousel that are to be sampled with a cap and septum.

100- μ L SYRINGE HEADSPACE INJECTION METHOD

The 48-vial carousel takes a standard 2-mL glass screw top vial with outside dimensions of 12 x 32 mm (12 x 35 mm with cap). The vial is sealed with a plastic screw cap with a 5-mm hole, and a white silicone rubber septum (8-mm diameter) faced with an inert film on one side. The inert side is the colored side of the septum. Place the colored side of the septum toward the sample solution.

- **Selecting Sample Vials.** A variety of sample vials are available from a number of sources. However, the vials you use with the AutoSampler must have the same external dimensions as the vials available from Varian (see **8200 AutoSampler Parts and Supplies**).
- **Installing Vial Septa.** The 2-mL vials (P/N 03-949835-00) are shipped complete with plastic screw caps and Teflon®-laminated silicone rubber septa. Always place the colored, chemically inert Teflon laminate face down (next to the contents of the vial).

Section 10

Automated Large Volume Injection Setup and Operation

INTRODUCTION

The Large Volume Injection (LVI) technique can improve GC and GC/MS detection limits by a factor of 10-50 times. This is done by transferring 10-50 times more analyte onto the GC column than with traditional injection, while eliminating the interference effects of excess solvent.

The LVI technique uses the 1078 Universal Capillary Injector and a 100 μ L liquid injection syringe. The sample is injected at a very slow rate while the injector temperature is set a few degrees below the solvent boiling point. The injector split valve is left open for a period of time to vent the solvent to the split vent. The split valve is then closed and the injector is rapidly heated to vaporize the solute material onto the GC column where the separation is made.

NOTE: Automated Large Volume Injection requires removal of the SPME agitation accessory. If this device is installed on your AutoSampler, refer to Section 7, Changing From SPME III to Liquid Sampling on Page 98.

COMPONENTS NECESSARY FOR LVI

1. 3000 Series GC
 - 8200 CX
 - Standalone PC control 8200 CX software (controlled through PC serial port), or
 - GC controlled 8200 CX (controlled by GC or GC Star Workstation).
2. 1078 Universal Capillary Injector. Cryogenic cooling is recommended.
 - 2 mm insert packed with deactivated glass wool (P/N 03-925350-00), or
 - 3.4 mm insert packed with 10% OV-101 on Chromosorb W-HP (P/N 03-918956-00), or
 - 0.5 mm open insert (P/N 03-925331-00)
3. Star Workstation Control (Version 4.5) or Standalone PC Control Software.

4. 100 μL liquid syringe (P/N 03-925414-01).
5. Optional items.
 - Capillary Column Quick Connect Kit (P/N 03-925355-90)
 - Gas Saver Option (P/N 03-925349-00)

The LVI system recommended for ease of use is the 3000 series GC equipped with the Standalone 8200 CX PC control software, 1078 UCI with cryo cooling option, and the 100 μL liquid injection syringe.

The GC controlled 8200 CX is not optimized for Large Volume Injection. The software control from the GC, whether programmed directly from the GC or via the Star Workstation, is optimized for a 10 μL syringe. Due to differences in syringe dimensions, if the 100 μL syringe is used with a GC controlled 8200 CX there is a conversion factor that must be used to determine the exact amount injected. For example, if you want to inject 25 μL with the GC controlled 8200 CX you would have to enter 3.0 μL to have 25 μL injected. The Standalone 8200 CX PC control software has built-in selection of a 10 μL or 100 μL syringe and has the conversion factor built-in. Using the PC control software you can program the 8200 CX to inject up to 100 μL accurately.

UPGRADING GC CONTROLLED 8200 CX AUTOSAMPLER TO PC CONTROLLED 8200 CX AUTOSAMPLER

To field upgrade a GC controlled 8200 CX order the Standalone Liquid Injection Kit (includes PC control software and cables). If you already have a SPME option, then you do not need this kit. The SPME option includes the necessary hardware and software for LVI.

Conditions for LVI with Various Solvents

The following tables give all of the conditions for making a 10-50 μL injection of a sample dissolved in a low boiling solvent (in this case MeCl_2 , bp 42°C) and a higher boiling, higher viscosity solvent (in this case EtOAc, bp 77°C). The GC column, column ramp rate, and final temperature will have to be chosen based on the compounds you are separating. The conditions given here are for anthracene. You can use these examples to develop the conditions for your LVI application. A detailed description of the LVI procedure has been included so that you can understand the purpose of the selected times, flow rates and temperatures.

The initial injector temperature is set a few degrees below the boiling point of the sample solvent. This prevents the solvent from vaporizing too quickly which might cause a loss of sample through the split vent. The injector split vent is set to 100 times the column flow so as to efficiently remove the solvent from the injected sample. If the split vent flowrate is set too low, excessive solvent will be injected onto the column resulting in peak shape distortion.

After 1.5 minutes the split vent is closed and the temperature of the injector is rapidly raised to 325°C. The sample is then vaporized onto the column which is held at the same temperature as the initial injector temperature. At 3.0 minutes the split vent is opened to vent any residual sample or solvent, cleaning the insert for the next injection. The injector is kept at 325°C until 3-5 minutes before the end of the method, at which time the injector is programmed to its initial temperature. If cryo cooling of the injector is used, you will have to adjust the time at which you program the injector to return to its initial temperature. Make it a target to have the injector and column oven reach their initial temperature at about the same time. This is a way to shorten the time between runs and minimize use of coolant.

Between 1.5 and 3.0 minutes the sample (less most of the solvent) is moved to the head of the column by closing the split vent and heating the injector. At the same time that the split vent is opened at 3.0 min the column temperature ramp is started. The column ramp is started to separate the components. See Diagram 1 for a graphic description of the LVI procedure.

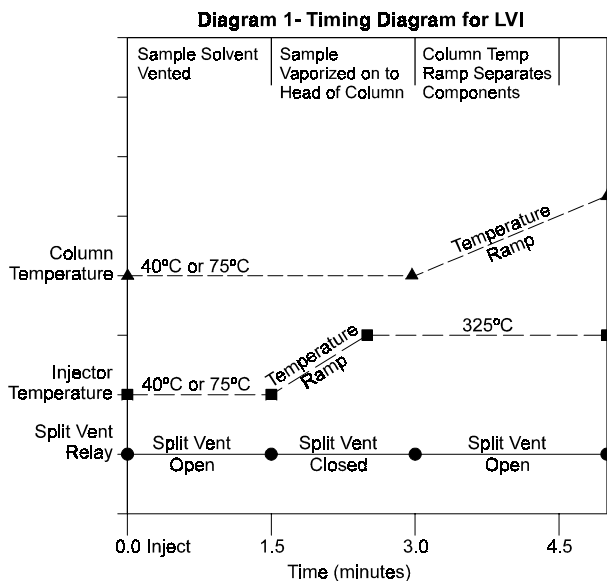

The relay times which control the split vent can be adjusted depending on the volume of sample injected. The smaller the injected volume the less time will be required to vent the solvent. For example, with a 10 μL injection the split vent can be closed after 1 min instead of 1.5 min. You would also need to adjust the time the injector temperature ramp is started to 1.0 min as it is synchronized with the closing of the split vent. Usually it is necessary to keep the split vent closed for 45-90 seconds depending on the amount of sample injected. The larger the sample the longer the time. The 90 second time was used successfully for an injection of 50 ng of anthracene.

The 8200 CX AutoSampler must be used in the User Defined mode so that four critical parameters can be adjusted. These parameters are solvent plug size, uptake speed, injection rate, and pause time. Solvent flush sampling is selected with both upper and lower air gaps chosen. The solvent plug size is set to 5 μL . Setting it larger can cause the upper air gap bubble to move to the plunger tip mixing the sample with the solvent plug. If this occurs the sample will not be completely flushed out of the needle. The uptake speed and injection rate are set to their lowest values. The pause time is set to its maximum (10 seconds) to allow sufficient time for the syringe to completely fill after sample withdrawal. If the sample is withdrawn too quickly cavitation will occur and more than 10 seconds (the maximum pause time) will be required for sample to fill in the cavity (bubble). Also, if injection rate is too fast the sample components might be lost by being carried out the split vent with the high concentration of solvent vapor generated in the insert.

Suggested Injector Inserts for LVI

- 2 mm packed with deactivated glass wool (03-925350-00). This insert is used with relatively clean samples. It is a general purpose insert shipped with the injector.
- 3.4 mm packed with 10% OV-101 on Chromosorb W-HP 80/100 (03-918956-00). This insert is useful for dirty samples and provides added retention for your sample components.
- 0.5 mm open insert (03-925331-00). This insert is recommended for trace levels of polar compounds where maximum inertness is desired. The recovery of sample with this insert can be significantly less than for the two above inserts.

The maximum recommended temperature for the above three deactivated inserts is 325°C. If deactivation is not an issue, higher temperatures can be used. The 10% OV-101 packing is rated to 350°C.

Using the GC Controlled 8200 CX AutoSampler for LVI

As discussed earlier, the 3000 Series GCs assume the syringe is 10 μL . By using special settings, it is still possible to make LVI injections. See Tables 2 and 3 for 8200 CX and 3000 GC settings. Table 1 gives the settings for injection volume and what volume is actually injected. To calculate volume injected multiply the set volume by 8.33.

Table 1: GC Controlled 8200 CX AutoSampler Injection Volume Settings

Set Volume (μL)	Volume (μL) Injected with 100 μL Syringe installed
1	8.3
2	16.7
3	25.0
4	33.3
5	41.7

The set volumes are entered in your sample list or in the dialog box for a manual injection when using the Star Workstation.

Special Note for GC Controlled 8200 CX

In some cases it is possible that solvent wash will not work correctly when using the 100 μL syringe. Because of tolerances of the syringe and the 8200 CX AutoSampler mechanism the plunger on the syringe may not withdraw far enough to allow the syringe plunger to clear the entry point of the syringe side arm (where the wash solvent enters the syringe). This will prevent the syringe from being flushed with solvent. If this situation occurs it is possible to adjust the plunger position from the GC using the following procedure:

1. Press **Shift** then **Inst Test** to initiate instrument diagnostics.
2. Press **Enter** at the end of the test
3. Select **Yes** then enter for Return to Test Menu?
4. Select **Yes** for Calibrate Plunger? The display now says Manually Position Plunger.
5. Turn the screw that controls plunger position (at the top of the AutoSampler mechanism) clockwise until the bottom of the plunger is positioned on the first line of the syringe barrel above the zero position.
6. Press **Enter** and this will be your new zero position. If the plunger is not positioned on the first line, repeat the above procedure. To exit the GC diagnostics press Enter repeatedly until Test Session Completed is displayed.

NOTE: If your GC is cold started you will have to redo your plunger calibration.

The problem described above does not occur with the Standalone PC control as the plunger is by default positioned at the first line above the zero.

Additional Hints and Procedures

1. **100 μL syringe installation.** The procedure for installing the 100 μL syringe is the same as the 10 μL syringe. Be sure to adjust the syringe bracket position so that there is no gap between the end of the syringe needle nut and the bracket it rests on.
2. **Plugged needle.** If your needle becomes plugged during use it will most likely cause a stall of the syringe plunger stepper motor causing the syringe to stop with the needle inserted in the waste cup. If you find your system has stopped and the needle is in the waste cup, you have a plugged needle.
3. **Replacement of needle.** Unscrew the nut holding the needle in the syringe. Pull the needle out of the syringe body. Carefully insert the new needle and tighten the nut 1/8-1/6 turn after the nut first starts to tighten. The needles for the 10 and 100 μL syringes are different. The needle for the 100 μL syringe uses a black Kalrez[®] seal without a spring while the 10 μL syringe needle uses a white Teflon[®] seal with a spring.
4. **The plunger seal** at the top of the syringe is adjusted at the factory and will generally not need adjustment.
5. **Syringe leak test.** To test the syringe plunger for leaks first remove the syringe from the 8200 CX. Pour a few mL of solvent (whatever you are currently using) in a 25-50 mL beaker. Place the needle in the solvent and withdraw some solvent into the syringe. Withdraw the needle from the solvent and push the syringe plunger at a moderate rate. If the plunger is leaking solvent will squirt out of the side arm. If there is no leak, the solvent will squirt out of the needle.
6. **Suggestion for Data Handling.** The solvent front for LVI is larger than with regular splitless injection. Setting Inhibit Integrate (II) in the data system timed events from 0-7 min prevents peak processing of the solvent peaks.

7. **How do you know if you have a Standalone 8200 CX?** If there is a cable running from the serial port of your computer (that has the Star WorkStation installed) to the 8200 CX you have a Standalone 8200 CX. The GC controlled 8200 CX has a cable that connects to a board inside the GC.
8. **Solvent purity.** Since you are injecting large volumes of solvent, you are now concentrating the impurities of the solvent. With LVI it is important to use high purity solvents for samples and wash solvents to minimize extra peaks in your chromatographic run. Run a blank for your solvent so that you know what peaks it is adding to your chromatogram.

Table 2: 8200 CX AutoSampler Conditions for LVI

	Standalone 8200 CX Setting	GC Controlled 8200 CX Setting
Sample Mode	User defined	User defined
Syringe	100 μ L	—
End time	1.00 min	—
Solvent	A or B (same as sample solvent)	A or B (same as sample solvent)
Solvent flush sampling	Yes	Yes
Syringe wash	30 sec	30 sec
Air dry after wash	No	No
Solvent plug size	5 μ L	0.5 μ L
Vial needle depth	90%	90%
Uptake speed	10 μ L/sec	1 μ L/sec
upper air gap	Yes	Yes
lower air gap	Yes	Yes
Pause time	10 sec	10 sec
Hot needle time	0.00 min	0.00 min
Injection rate	2.0 μ L/sec	0.2 μ L/sec
Needle residence time	0.05 min	0.05 min

Table 3: 3000 Series GC Conditions for LVI

	For EtoAc (bp 77°C)	For MeCl ₂ (bp 42°C)
1078 INJECTOR		
Initial temperature	75°C	40°C
Initial hold time	1.50 min	1.50 min
Final temperature	325°C	325°C
Rate	200°C/min	200°C/min
Hold time	10.90 min	8.90 min
Coolant to injector on	Yes	Yes
Coolant timeout	Infinite	Infinite
GC COLUMN OVEN		
Initial temperature	75°C	40°C
Initial hold time	3.00 min	3.00 min
Thermal stabilization time	2.00 min	2.00 min
Final temperature	270°C	270°C
Rate	15°C/min	25°C/min
Hold time	2.00 min	3.80 min
GC RELAY (FOR SPLIT/SPLITLESS VALVE)		
Initial Relay state	off (split vent open)	off (split vent open)
Relay program - 1.50 min	Relay 1 on (split vent closed)	Relay 1 on (split vent closed)
Relay program - 3.00 min	off (split vent open)	off (split vent open)
COLUMN/INJECTOR FLOW RATES/MISCELLANEOUS		
Column	30 meter 250 μ ID 0.25 μ film DB-5	30 meter 250 μ ID 0.25 μ film DB-5
Column flowrate	1.5 mL/min at 75°C (16 psi He)	~1.8 mL/min at 40°C (16 psi He)
Injector septum purge	5 mL/min	5 mL/min
Split vent flow rate	150 mL/min	150 mL/min
Test sample	Anthracene (2 ng/ μ L in EtOAc)	Anthracene (2 ng/ μ L in MeCl ₂)
Wash Solvent	EtoAc	MeCl ₂

Section 11

Performing Injections

If you are using the Varian Star Workstation to control your instruments, you can refer to the Workstation Operation and Tutorial manuals for more detailed information on performing injections.

INJECTING A SINGLE SAMPLE

Before injecting a sample, be sure you have

- Turned on the AutoSampler. The power switch is located on the rear of the tower.
- Configured the AutoSampler to your GC. This is described in **How to Configure the AutoSampler** on Page 36.
- Built your Method(s). (See Section 5)

ACTIVATE A METHOD

To activate a method, proceed as follows:

1. Turn on the AutoSampler and the GC.
2. Double-click on the “System Control” icon in the Varian Star group of the Program Manager. The System Control Configuration screen appears.

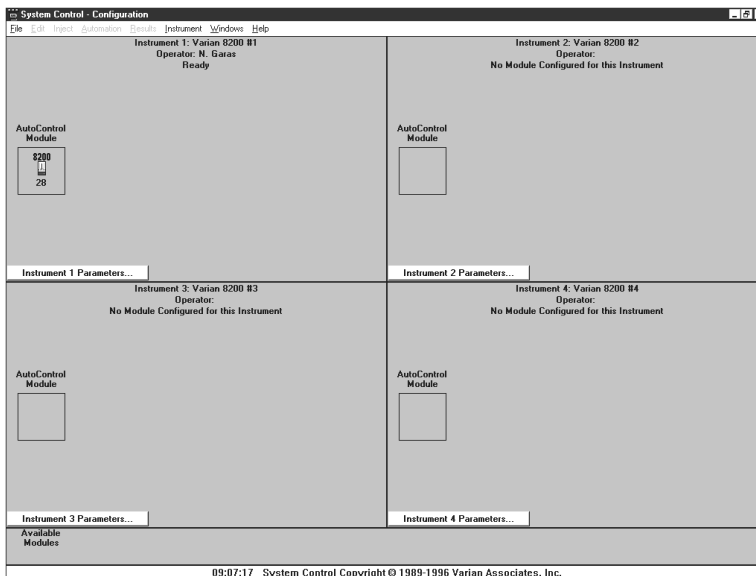

3. Click on Varian Star #n under Instrument in the menu bar for the instrument you wish to inject your sample into (see **How to Configure the AutoSampler** on Page 36, for an explanation of the naming of instruments).

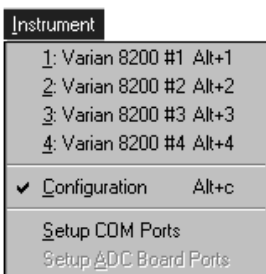

The System Control - Varian Star #n window appears.

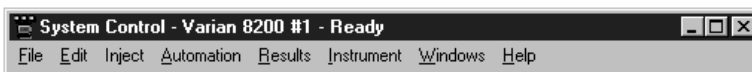

4. Click on **Method File** under File in the menu bar at the top of the System Control - Varian Star #n window. Then click on **Activate**.

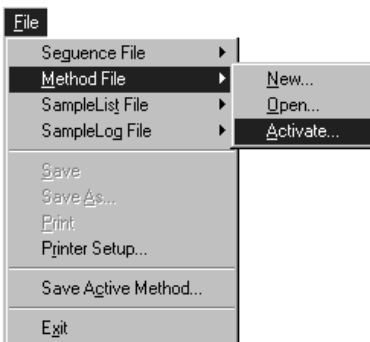

5. The Activate a System Control Method File dialog box appears. This dialog box defaults to displaying only files with the .mth extension. Type the name of the method file you wish to activate and click on **OK**, or scroll through the list of files, and double-click on the name of the method file.

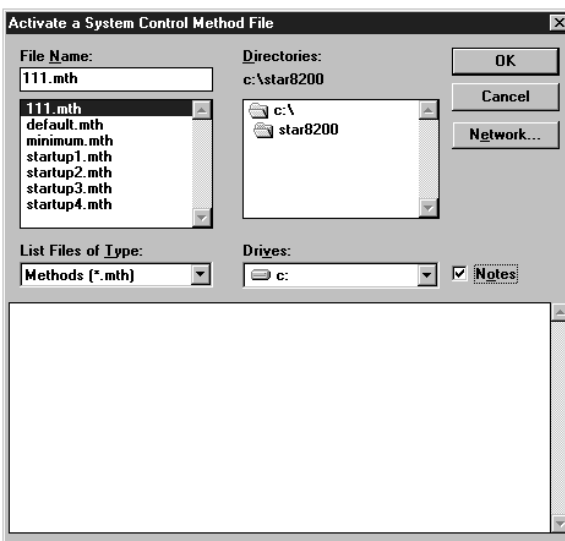

NOTE: You can view the Method Notes by selecting Notes... in the Method File dialog box. If you want the Notes window to appear every time you change and save a Method, check the “Prompt for Notes on Save” box in the Method Notes window.

6. A dialog box asks you if you want to inject or recalculate samples using this method. Click on **Inject**.

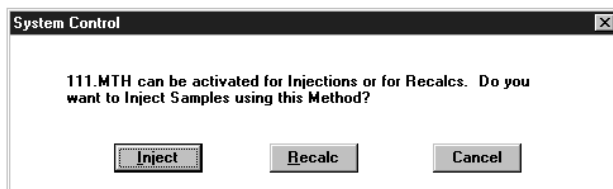

7. Wait for "Ready" to appear in the title bar of the System Control window.

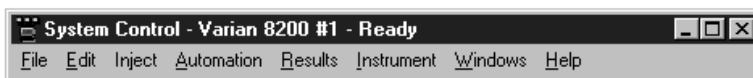

INJECT THE SAMPLE

To inject the sample, proceed as follows:

1. Click on "Inject Single Sample..." under Inject in the menu bar.

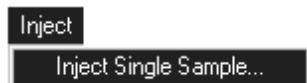

2. The Instrument Parameters dialog box appears.

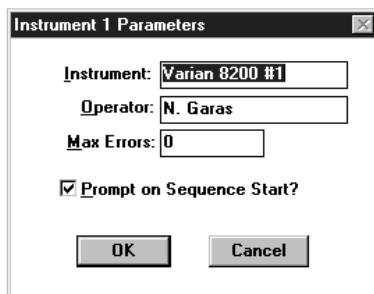

- You may change the Instrument and Operator fields if you wish. These fields are only used if you have a Varian detector.
- The Max Errors field sets the maximum number of non-fatal errors the Instrument will tolerate. The default value is 0.
- Selecting "Prompt on Sequence Start" will cause this Instrument Parameters dialog box to be displayed whenever you perform an injection or begin a sequence. If you do not wish this window to appear, deselect this item.

3. If the Instrument Parameters dialog box is open, click on **OK**.
4. The Inject 8200 Sample dialog box appears. Enter the sample name or other identification, along with the number of injections and the vial number you wish to inject from.

Sample Name	Sample Type	Inj	Injection Notes	AutoLink	Vial	Injection Volume	Automix Routines
Default Sample	Analysis	1	none	none	1	1.0	none

Inject the Sample using the Method:

C:\STAR8200\111.MTH

If you want to change the Method to be used for the injection, use the Browse button to bring up the **Select a Method File** window.

5. Click on the Inject button. The AutoSampler begins sampling the vial you specified and then injects it.
 - The Star Chromatography Workstation builds two files once you have clicked Inject: MANUALn.SEQ and MANUALn.SMP. These files replace any previously active Sequence and SampleList files. MANUALn.SMP stores the data you entered in the Inject Sample dialog box.
 - Status messages appear on the message bar at the bottom of the System Control window during the injection.
6. To display the Sequence log when the injection has completed, double-click on the message bar at the bottom of the System Control window.

```

Sequence Log: MANUAL1.SEQ
11:40:17 Sequence MANUAL1.SEQ Began
11:40:17 SampleList MANUAL1.SMP Activated
11:40:17 Method 111.MTH Activated
11:40:22 Beginning Vial 1 Injection 1 on Tue Jun 11 11:40:22 1996
11:42:02 Completed 1 Inject Actions for MANUAL1.SMP with 0 Errors
11:42:02 Completed 0 AutoLink Actions for MANUAL1.SMP
11:42:02 Completed 0 New Calibration Block Actions for MANUAL1.SMP
11:42:02 Completed 0 Calibration Block Report Actions for MANUAL1.SMP
11:42:02 End of Sequence MANUAL1.SEQ reached.
  
```

CREATING AND RUNNING A SAMPLELIST

The SampleList allows you to identify and set different parameters for one to hundreds of samples. The SampleList is intended for use in Automation when performing large numbers of injections. The Star Chromatography Workstation always has an active SampleList associated with it. You activate SampleLists in much the same way you activate Methods. You can also edit a SampleList.

Before building a SampleList, be sure you have

- Turned on the AutoSampler and the GC.
- Configured the AutoSampler to your GC. This is described in **How to Configure the AutoSampler** on Page 36.
- Built your Method(s).

BUILD THE SAMPLELIST

To build a SampleList, proceed as follows:

1. Double-click on the “System Control” icon in the Varian Star group of the Program Manager. The System Control Configuration screen appears.
2. Click on Varian Star #n under Instrument in the menu bar for the instrument you wish to inject your sample into (see **How to Configure the AutoSampler** on Page 36, for an explanation of the naming of instruments.). The System Control - Varian Star #n window appears.
3. Click on “Active SampleList” under Windows in the menu bar.

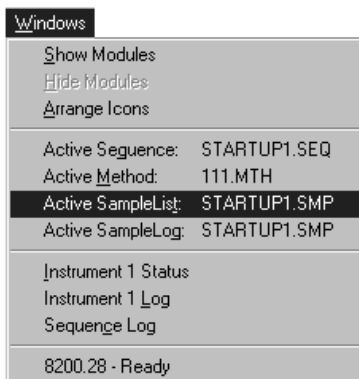

4. The Active SampleList appears.

- The Active SampleList will be named STARTUPn.SMP where n is the number you assigned your GC in **How to Configure the AutoSampler**, Page 36. This SampleList should initially display a single line.

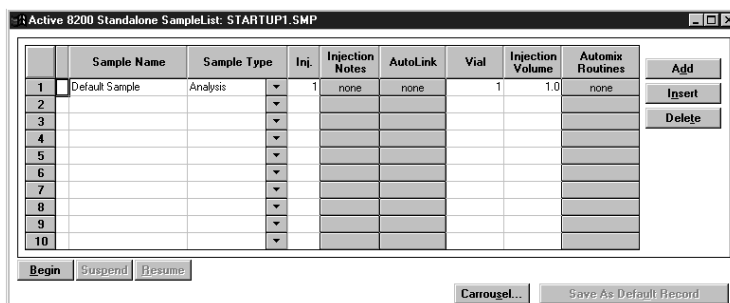

- To resize the SampleList, click on either the borders or corners of the SampleList and drag it to the desired size. You should ordinarily resize your SampleList so that it extends from the left to right sides of your monitor.
- To scroll the cells to the right or to the left, use the scroll bar under the right half of the table.
- To add a line, click on the Add button on the right side of the SampleList. A default entry is appended to the SampleList.

FILL IN THE SAMPLELIST

To fill in the SampleList, proceed as follows:

- With the Active SampleList window open, type the name or other identification of the sample you wish to inject in the Sample Name field.

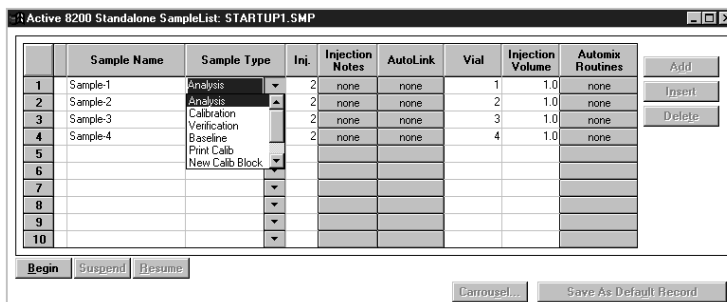

- Select sample type: Analysis, Calibration, Verification, or Baseline.

3. Enter the number of injections to be made from the sample in the injection (**Inj.**) field.
4. Enter information or comments about the sample in the **Injection Notes** field.
5. Verify the vial position on the carousel that you will be putting your sample into.
6. Enter the volume to be injected in the **Injection Volume** field if you are doing liquid injections.

The Copy Carousel feature can speed up the process of SampleList building by automatically entering lines for each vial found in the carousel. The vial position will be filled in for you along with your SampleList defaults.

1. Place a few septum-capped vials in your autoSampler carousel and click the Carousel button. The Copy Carousel window appears.

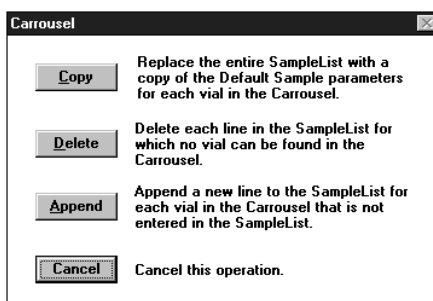

2. Click on the Copy button. The Scanning Carousel window appears.

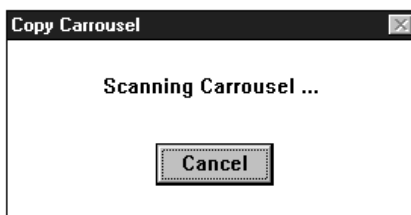

The autoSampler will rotate and scan the Carousel. When scanning is finished, a line will be entered into the SampleList for each vial position in the Carousel.

Active 8200 Standalone SampleList: STARTUP1.SMP

	Sample Name	Sample Type	Inj.	Injection Notes	AutoLink	Vial	Injection Volume	Automix Routines	
1	Sample - 1	Analysis	1	none	none	1	1.0	none	<input type="button" value="Add"/> <input type="button" value="Insert"/> <input type="button" value="Delete"/>
2	Sample - 2	Analysis	1	none	none	2	1.0	none	
3	Sample - 3	Analysis	1	none	none	3	1.0	none	
4	Sample - 4	Analysis	1	none	none	4	1.0	none	
5	Sample - 5	Analysis	1	none	none	5	1.0	none	
6	Sample - 6	Analysis	1	none	none	6	1.0	none	
7	Sample - 7	Analysis	1	none	none	7	1.0	none	
8	Sample - 8	Analysis	1	none	none	8	1.0	none	
9									
10									

HOW TO SET THE DEFAULT SETTINGS

To set the default settings, proceed as follows.

1. With the Active SampleList window open, modify a line of your SampleList to reflect the desired default conditions.
2. Click on the line number associated with the line that you just modified.
3. Click on “Save As Default Sample.”
4. A window asks you whether you wish to save the save SampleList line as the default sample. Click **Yes**.

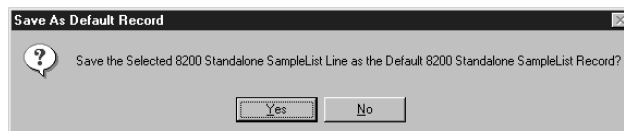

5. The new lines that you now add will have the same values that you set in the default line. You may change the default settings at any time by repeating this procedure.

Active 8200 Standalone SampleList: STARTUP1.SMP

	Sample Name	Sample Type	Inj.	Injection Notes	AutoLink	Vial	Injection Volume	Automix Routines	
1	Sample Name Test	Analysis	5	none	none	7	1.0	none	<input type="button" value="Add"/> <input type="button" value="Insert"/> <input type="button" value="Delete"/>
2	Sample - 2	Analysis	1	none	none	2	1.0	none	
3	Sample Name Test	Analysis	5	none	none	7	1.0	none	
4	Sample Name Test	Analysis	5	none	none	7	1.0	none	
5	Sample Name Test	Analysis	5	none	none	7	1.0	none	
6									
7									
8									
9									
10									

HOW TO DELETE SAMPLELIST ENTRIES

1. With the Active SampleList window open, click on the number at the left side of the SampleList beside the first entry you wish to delete.
2. Drag down the number column until you have highlighted all of the entries you wish to delete.
3. Release the mouse button and then click on the Delete button at the right side of the SampleList.

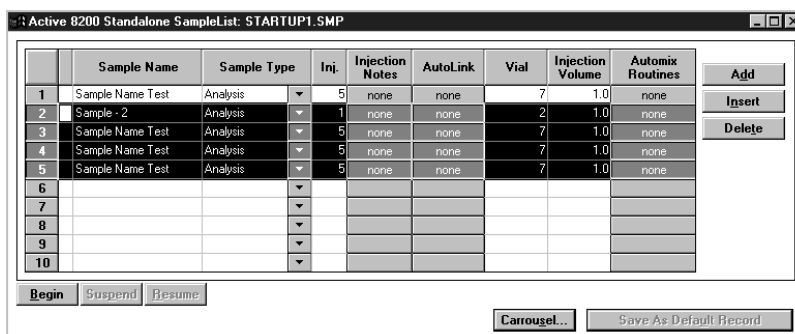

- All of the highlighted lines are removed.

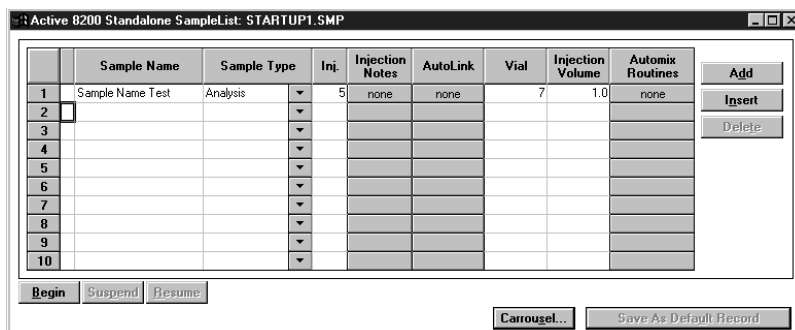

DOWNLOADING A METHOD FROM THE SAMPLE LIST

To download a method and associate it with samples in the SampleList, proceed as follows:

1. Build a SampleList as described in **Build the SampleList** on Page 130.
2. Insert an entry before the desired sample and click on the Sample Type column cell. The cell becomes highlighted.

- Click on the arrow at the right of the cell to bring up a pull-down menu, then click on **Activate Method**.

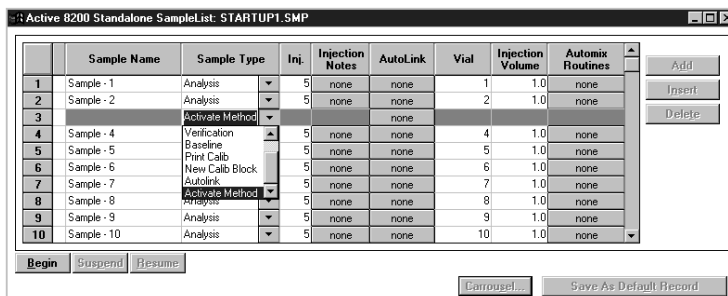

- Click on the cell under the AutoLink column across from the Sample Type cell selected in Step 2. The **Activate Method** window opens.

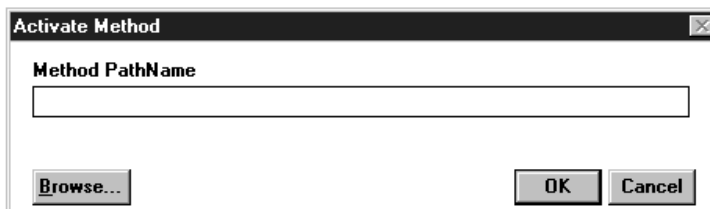

- Select the Method path name to be activated by using the Browse button or typing in the name.

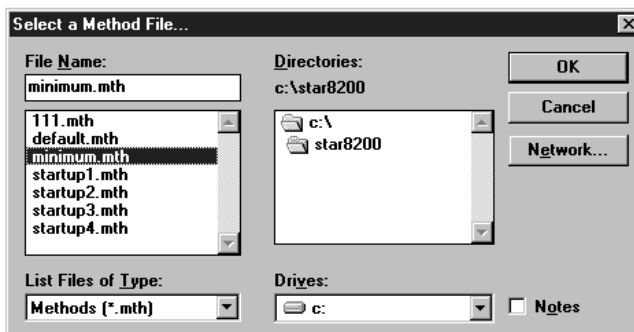

- Click on **OK**. The Method is entered in the SampleList.

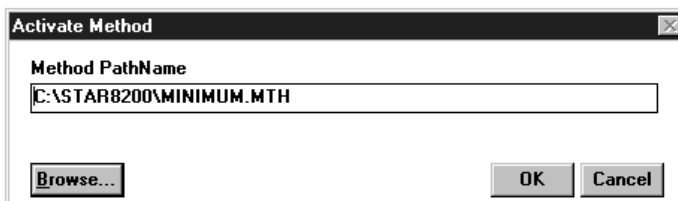

- Fill in the SampleList in the lines following for the samples you wish to associate with the method of Step 6.
- Repeat steps 1 through 8 for each series of samples. See the following diagram.

Method Download Lines

	Sample Name	Sample Type	Inj.	Injection Notes	AutoLink	Vial	Injection Volume	Automix Routines
1	Sample - 1	Analysis	5	none	none	1	1.0	none
2	Sample - 2	Analysis	5	none	none	2	1.0	none
3	Sample - 3	Activate Method			minimum.mth			
4	Sample - 4	Analysis	5	none	none	4	1.0	none
5	Sample - 4	Analysis	5	none	none	5	1.0	none
6	Sample - 5	Activate Method			111.mth			
7	Sample - 5	Analysis	5	none	none	7	1.0	none
8	Sample - 6	Analysis	5	none	none	8	1.0	none
9	Sample - 7	Activate Method			startup1.mth			
10	Sample - 7	Analysis	5	none	none	10	1.0	none
11	Sample - 8	Analysis	5	none	none	11	1.0	none

BEGIN THE SAMPLELIST

You are now ready to inject the samples in your SampleList. Since you have been using the Active SampleList for the instrument you have configured, there is no need to save your edits. They are already saved.

- Click on the Begin button.
- If the Instrument Parameters dialog box is displayed, click on **OK**. The Begin SampleList window appears.

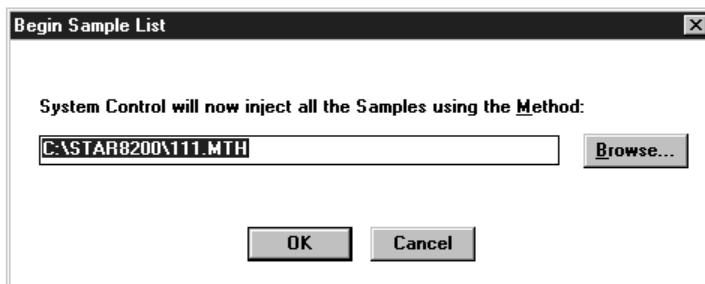

This dialog box will show the current active Instrument Method. If you wish, you can select a different Method to use at this time by using the Browse... button. When you have selected your Method, click on **OK**. The 8200 AutoSampler will search for the vials you have specified in your SampleList and make the injections.

BUILDING AND RUNNING A SEQUENCE

A Sequence is essentially a list of Methods and SampleLists that will be run together under automation. The Star Chromatography Workstation always has an active Sequence associated with it. When you activate and subsequently begin a sequence, there is no need for you to individually activate either the Method or the SampleList since the Sequence does that for you.

Before building a Sequence, be sure you have

- Turned on the AutoSampler and the GC.
- Configured the AutoSampler to your GC. This was described on Page 36, **How to Configure the AutoSampler**.
- Built your method(s).
- Built the SampleList(s). This was described in **Creating and Running a SampleList** on Page 130.

OPEN THE ACTIVE SEQUENCE WINDOW

To open the Active Sequence window, proceed as follows:

1. Double-click on the “System Control” icon in the Varian Star group of the Program Manager. The System Control Configuration screen appears.

2. Click on Varian Star #n under Instrument in the menu bar for the instrument you wish to inject your sample into (see **How to Configure the AutoSampler** on Page 36, for an explanation of the naming of instruments). The System Control - Varian Star #n window appears.
3. Click on “Active Sequence” under Windows in the menu bar at the top of the System Control screen.

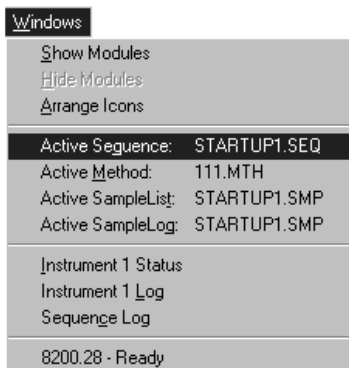

- The Active Sequence window appears.

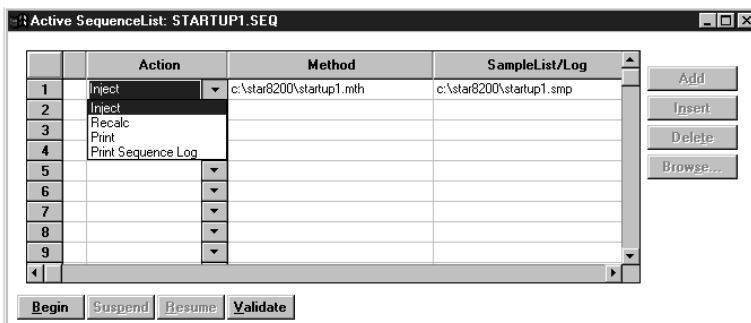

HOW TO ADD A LINE

To add a line to the Sequence, proceed as follows:

1. With the Active Sequence window open, click on the Add button located on the right side of the Sequence.
 - A default entry consisting of the Action Inject, the Method STARTUPn.MTH and the SampleList/Log STARTUPn.SMP appends to the Sequence.

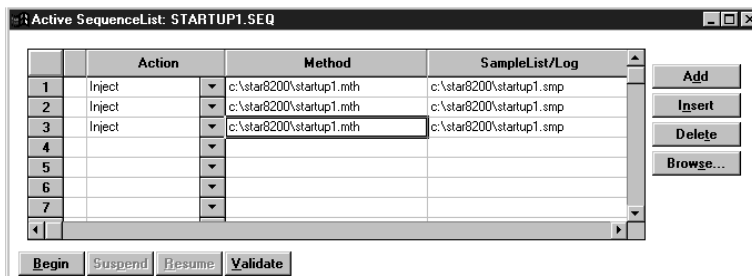

SET THE ACTION, METHOD AND SAMPLELIST/LOG

To set the Action, Method, and SampleList/Log, proceed as follows:

1. Set the Action to “Inject” by clicking on the cell to be modified, scrolling through the list of actions until you come to “Inject,” and then clicking on “Inject.”
2. Set the Method by clicking once on the Method cell and then clicking on Browse. From the Select a Method File dialog box, if you are not in the Star directory, change directories to Star, then double-click on the name of the method (.mth file) you wish to insert.
3. Set the SampleList/Log in the same way: click on the SampleList/Log cell, and click on Browse. From the Select a Method File dialog box, if you are not in the Star directory, change directories to Star, then double-click on the name of the sample list (.smp file) you wish to insert.

BEGIN YOUR SEQUENCE

To begin your sequence, proceed as follows:

1. When the System Control window indicates Ready at the top of the window, click on the Begin button at the bottom of the active sequence window.
2. Change the fields in the Instrument Parameters dialog box as appropriate. A dialog box tells you the next actions the Star Chromatography Workstation will take.
3. Click on **OK**. A series of messages appears in the message bar at the bottom of the System Control window.

4. Double-click on the message bar. The Sequence log appears, indicating that the selected Method and SampleList have been activated. The Begin button is grayed out and the Suspend button is active.
5. When the Sequence has completed, the header in the System Control window again displays Ready.

AUTOMIX

Automix is a feature available in the SampleList when performing liquid injections. When performing an Automix routine, the AutoSampler extracts a specified amount of liquid from a vial, and then transfers that liquid to the sample vial from which the injection is to be made.

The AutoSampler must be configured for a 10- μ L syringe.

NOTE: Do not use Automix with the 100- μ L syringe.

To run Automix, proceed as follows:

1. Build a SampleList as described in **Creating and Running a SampleList** on Page 130.
2. Fill in the SampleList until you reach the Automix Routines column.
3. Click on box under the Automix Routines column for the sample you wish to mix. The box will read 'none.'

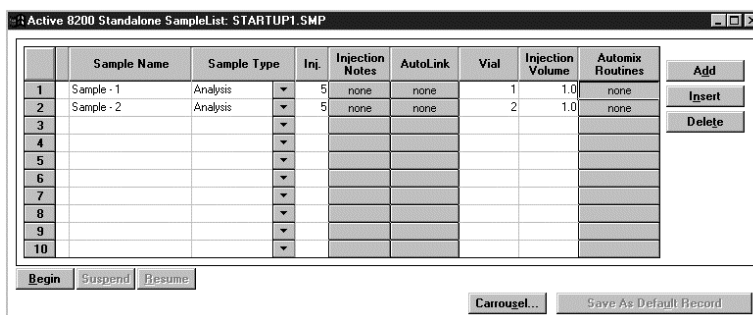

4. Click on **none** in the Automix Routines column. The Automix Routines dialog box appears.

- Click on the first line of the Automix Routines window. The default parameters appear.

	Automix Name	Vial	Volume	Mixes	Mix Stroke	Washes	Reaction Time
1	Add Standards	48	2.0	10	6.0	2	3.5
2							
3							
4							
5							
6							
7							
8							
9							

Automix First Injection Only

- Enter a name to describe the function of this Automix routine under Automix Name. You may enter up to 19 characters.
- Enter the number of the vial number from which the liquid will be extracted under Vial.
- Enter the amount of liquid to be extracted under Volume. Range: 0.1 to 10.0 μL .
- Enter the number of mixes to be performed on the sample vial after liquid has been transferred under Mixes. Each mix withdraws the mixing stroke volume from the sample vial and squirts it back into the vial. Range: 0 to 100.
- Enter the syringe volume used for mixes under Mix Stroke. Range: 0.1 to 10 μL .
- Enter the number of syringe washes to be performed after mixing under Washes. Range: 0 to 9.
- Enter the delay time following mixing before the sample is injected under Reaction Time. Range: 0.0 to 99.9 minutes.

- Click on **OK** to return to the SampleList window.

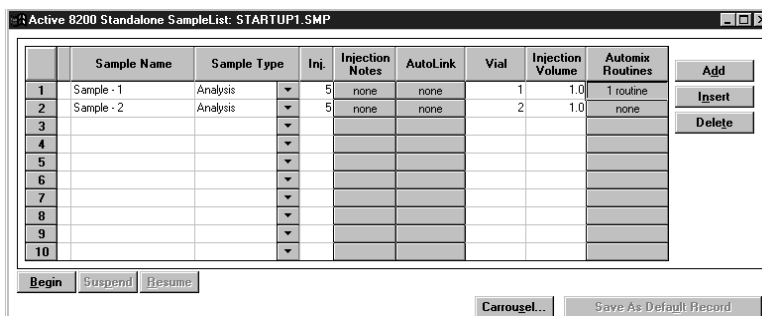

When this sample is processed, the following takes place:

- The AutoSampler selects the vial specified in the Automix Routines window.
- The syringe withdraws a volume equal to the amount specified in the Automix Routines window from the Automix Routines vial and transfers the contents to the vial specified in the SampleList window.
- The syringe mixes the sample by withdrawing the amount specified in the Automix Routines window from the SampleList vial and squirting it back into that vial. This is done the number of times specified in the Automix Routines window.
- The syringe is washed the number of times specified in the Automix Routines window. Countdown of the reaction time specified in the Automix Routines window begins.
- After the reaction time countdown has completed from the last Automix routine, the syringe withdraws and injects the volume specified in the SampleList window from the SampleList vial into the GC.

Section 12

Application Notes

To obtain copies of the following Application Notes, or for other information about Varian Products, contact your local Varian Sales Representative.

- Method Development Tips for the Automated SPME System (Varian GC Advantage Note 11) (Included in this section)
- Determination of Halogenated Pesticides with Automated SPME and Agitation (Varian GC Advantage Note 17)
- A Demonstration of Automated Solvent Flush Injection to Eliminate Sample Discrimination in the Determination of pesticides by Splitless Capillary Injection (Varian Application Note 28)
- Automatic Injection of Difficult Samples: Fine-tuning the Conditions for Viscous Samples (Varian Application Note 42)
- Automatic Injection of Difficult Samples: Fine-tuning the Conditions for Volatile Samples (Varian Application Note 43)
- Determination of Volatile Organic solvents in Water by Headspace Sampling with the 8200 CX AutoSampler (Varian Application Note 46)
- Profiling Flavors in Alcoholic and Non-Alcoholic Beverages with Automated Solid Phase Microextraction (SPME Application Note 1)
- Determination of Residual Solvents in Pharmaceuticals with Automated Solid phase Microextraction (SPME Application Note 2)
- Determination of a Wide Range of Organic Impurities in Water with Automated Solid Phase Microextraction (SPME Application Note 3)
- Flavor Analysis of a Fruit Beverage with Automated Solid Phase Microextraction (SPME Application Note 4)
- Analysis of Therminol in Process Water Using Solid Phase Microextraction (SPME Application Note 5)
- Characterization of Flavor Components in Wines with Solid Phase Microextraction (SPME), GC and GC/MS (SPME Application Note 6)

- Determination of Residual Solvents and Monomers in Polymers with Solid Phase Microextraction (SPME) and GC/MS (SPME Application Note 7)
- Determination of Trace Methanol in Caustic Industrial Product with Automated Solid Phase Microextraction (SPME Application Note 8)
- Blood Alcohol Determination with Automated Solid Phase Microextraction (SPME Application Note 9)
- Rapid Analysis of BTEX and TPH in Water using Solid Phase Microextraction (SPME Application Note 10)
- The Advantages of SPME Agitation (SPME Application Note 11)

Method Development Tips for the Automated SPME System

GC Advantage Note 11

Zelda Penton, Varian Chromatography Systems

Introduction

Automated solid phase microextraction (SPME) can yield ppb detection limits for organic compounds in water or solids. Linearity is excellent, and relative standard deviations are often better than 3%. However, the technique is new and many questions have been raised by chemists who are excited by the possibilities and would like to utilize SPME in their analytical procedures. The questions fall mostly in the category of SPME hardware and sampling parameters. These questions will be addressed here. Experience has shown that sample preparation is the key to good results with SPME; therefore, techniques for working with volatile samples will also be discussed.

For recommendations on injectors and injector inserts, see the SPME operator's manual. Some guidelines to help the user get started are given below. These suggestions are discussed in greater detail in the ensuing sections.

Guidelines For Getting Started

1. A new fiber must be conditioned by desorbing for a minimum of five minutes in an injector that is at least 10°C hotter than the temperature to be used during the analysis. The GC column should then be temperature programmed; this procedure should be repeated until there are no extraneous peaks.
2. The fiber and injector septum should be changed after approximately 100 runs.
3. For water soluble analytes, sensitivity can be enhanced by saturating the sample with salt (usually sodium chloride or sodium sulfate).
4. Standards and samples are normally prepared and diluted in **storage containers** and then transferred to AutoSampler **vials** for analysis. Prepare samples and standards carefully so that volatiles are not lost:
 - a. After preparation, water samples containing volatiles should completely fill the storage container without any headspace.
 - b. Store samples in the refrigerator. Chill the AutoSampler vials before adding the sample.
 - c. Transfer samples to the AutoSampler vials with a pipette of sufficient capacity to deliver the entire sample in one step. The outer diameter of the pipette should be small enough to allow the pipette to **easily fit** into the AutoSampler vial.
5. For headspace sampling, use up to 0.8 mL sample; for liquid sampling use 1.2 mL. Do not fill the AutoSampler vial to the top!
6. A reasonable adsorption time is 15 minutes with 2 minutes desorption; however, these conditions should be optimized for each analysis. It is not necessary to achieve equilibrium if the total analysis time will be prolonged. For many samples, RSD's under 5% can be obtained prior to reaching equilibrium.

Hardware And Software

What fibers are available?

The 100- μ m polydimethylsiloxane (PDMS) fiber should be used for the majority of applications but two other fiber types are available. The features of currently available fibers are summarized below.

PHASE	ADVANTAGES	DISADVANTAGES
100- μ m PDMS	High sample capacity. Suitable for a wide variety of applications-volatile compounds such as dichloromethane to semi-volatiles (some pesticides).	Longer adsorption time required to reach equilibrium. Possibility of carryover for some semivolatiles.
7- μ m PDMS	Bonded fiber which allows a higher desorption temperature than the 100- μ m PDMS (Maximum operating temperature 320°C vs. 260°C for the 100- μ m fiber). Faster desorption-therefore initial column temperature during the GC run can be higher. This shortens the total run time. Thinner phase means shorter time to reach equilibrium.	Low sample capacity. Not suitable for volatiles.
Polyacrylate	Greater affinity for polar compounds than above fibers.	This phase is more of a solid than the PDMS phases; therefore diffusion rates are slow and equilibration times are long.

All of the data presented in the figures and tables was obtained with 100- μ m PDMS fibers.

How long does a fiber last?

The fiber life will vary with experimental conditions but typically, there is no evident deterioration in chromatography up to 100 runs when desorbing into an injector heated to 220°C. This is true even when immersing the fiber into water that is saturated with salt and is at pH 2. One sign of an aging fiber is deterioration of precision. This might also be due to the aging of the septum. It is best to change the septum when changing the fiber.

Is it necessary to use a septumless injector?

Users sometimes express concerns that the sheath on the fiber rod might core the injector septum. Figure 1 shows no change of retention time after 46 runs, indicating that the septum is intact. Again, the practice at Varian is to change the septum and the fiber at the same time after about 100 runs according to the following procedure:

1. A new septum is installed.
2. The AutoSampler carriage is lowered manually so that the fiber sheath pierces the septum several times.
3. The new septum is removed and inspected. If loose particles of septum material are present, they are removed.
4. The septum is reinstalled.

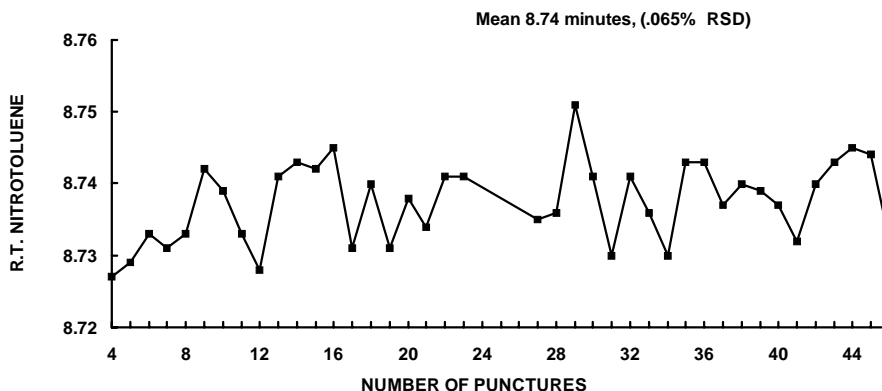
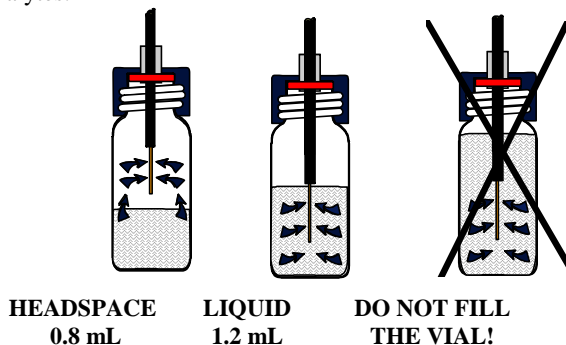

Figure 1. Demonstrating the integrity of the injector septum after 46 SPME injections. Note that the scale on the Y axis is 0.04 minutes. A Thermogreen™ LB-2 (Supelco) septum was used in this study.

How much sample should be added to the AutoSampler vials?

The AutoSampler vial should not be filled to the top. It was observed when sampling volatiles, that equilibrium was attained faster when headspace was present, even when liquid was being sampled. Furthermore, immersion of the metal fiber-support rod in the liquid sample may result in the adsorption and/or breakdown of analytes.



A final reason not to fill the vial, is the possibility of carryover if liquid sample enters the fiber sheath. A sample volume of 1.2 mL is recommended for liquid sampling and the maximum volume should be 0.8 mL when sampling the headspace.

What are the recommended adsorption and desorption times?

Adsorption time varies inversely with the volatility of the analyte and also depends upon the relative volumes of the phases in the vial. Satisfactory precision can often be obtained without achieving equilibrium. This is convenient if the GC cycle time is relatively short and prolonged sampling times would greatly lengthen the total analysis time. A reasonable point for sampling is fifteen minutes, but adsorption times may be longer if the GC cycle time permits.

At least 2 minutes is recommended to desorb all traces of the analyte to minimize carryover. The injector temperature should normally be at least 200°C but should not be higher than the temperature limit of the analytical column or the SPME fiber. If carryover is present, a longer desorption time and/or higher injector temperature should be used.

Is cryofocusing necessary?

Injector: After initial studies, it was concluded that injecting into a hot injector gives the best results, even when the sample contains very volatile analytes such as vinyl chloride.

Column: With a 0.53 mm column coated with a 3-micron moderately polar phase, cryogenic focusing is required in the column oven to elute vinyl chloride with a good peak shape. For dichloromethane (BP 40°C) and compounds with higher boiling points, cryogenics are unnecessary. SPME sampling does not require special GC conditions.

Is the fiber easily saturated and do compounds tend to be displaced in mixtures?

This depends on many factors including sample size, the affinity of the fiber for the components of a particular sample, and the fiber thickness. It was found in recent studies that there was a linear response to benzene at concentration ranges greater than 300 ppm. In another experiment, benzene gave the same response whether it was the only organic compound in water or in a test mixture containing several other compounds (Table 1). Nevertheless, it is important in developing and validating a method, to do recovery studies. Displacement effects may be minimized by diluting the sample to a lower concentration. With 2-mL AutoSampler vials, the probability of fiber saturation is reduced.

conc. (ppm)	MeCl ₂	CHCl ₃	Benzene	TCE	Dioxane	Toluene	Xylene	TMB*
1	4281	3567	175183	51579	1203	308884	427923	637614
2	8471	6322	337571	101351	2165	617885	872322	1251551
4	17894	12478	704235	207027	4192	1233313	1713901	2331268
1			154458					
2			328038					
4			674635					

Table 1. FID area counts for benzene alone in water at (bottom 3 rows) and in a mixture with several other organic compounds in water (top 3 rows). All of the compounds were at the concentration shown at left except chloroform which was at half the concentration shown. These data were obtained by SPME fiber sampling of the liquid phase (1.2 mL).

*1,2,4-trimethylbenzene

Is it better to sample the liquid or the headspace?

Theoretically, the response should be the same if the volumes sampled are similar. This has been found to be the case for the compounds listed in Table 1. Practically, for compounds of very low volatility, the adsorption time from the headspace would be long and liquid sampling would be preferable.

Does the fiber pick up contaminants in the air that will interfere with the analysis?

A new fiber needs to be desorbed for 15-20 minutes. When a new 100-micron fiber is desorbed for 3 minutes, followed by a GC run, typically, after six GC runs, the blank is clean. For a fiber that has been used, the first run each day should be a blank. Ghost peaks occasionally appear from AutoSampler vial septa. If this occurs, the user should try a different brand of septum and/or bake the septa before use.

In order to minimize the presence of extraneous peaks, the SPME software parameters should be set so that the GC is ready for the sample to be injected immediately after adsorption. See the SPME manual for a detailed explanation.

Sample Preparation

Experience has shown that poor precision and accuracy often result from improper sample handling.

- It is a common practice to prepare a stock solution of analytes in methanol and then add a small aliquot to water. This method is acceptable with SPME and results are the same as adding organics directly to water if the total level of methanol is less than 1%.
- Saturation of the standards and samples with sodium chloride or sodium sulfate is useful in two situations:
 - The analytes are polar and soluble in water.
 - The samples contain salts and it is desired to minimize matrix differences.
- When determining acidic compounds such as phenols, lower the pH; for basic compounds such as amines, raising the pH will enhance sensitivity.
- It is important to keep the concentrations of all of the components in an aqueous solution sufficiently low so that they remain dissolved in water.

For volatile compounds, additional guidelines should be followed:

- When preparing standards of volatiles in water, the liquid should fill the entire storage container without any headspace.
- Losses can occur when diluting the high level standard in preparation for a linearity study. To minimize errors, fill the containers that are to contain diluted standards with cold water at the correct volume for the dilution, quickly pour the concentrated standard into the containers, cap, mix and refrigerate. For example, when diluting to 1/2 and 1/4 the concentration of the highest standard, take 40 mL vials (44 mL when filled to the top), add 22 mL and 33 mL of cold water; then pour in the concentrated standard.

- If salt is added or the pH is adjusted, great care should be taken to minimize losses. For example, if the samples and standards are to be diluted in water, the salt can be added to the water *before* the dilution is made.

Chill the AutoSampler vials before adding the samples. Remove the standards and samples from the refrigerator, uncap them and quickly transfer aliquots to the AutoSampler vials, using a pipette that easily fits into the neck of the vial.

Ideally, the sample will be transferred with a disposable 1-mL serological pipette that is calibrated to deliver up to 1.2 mL and is graduated in 0.1 mL increments.

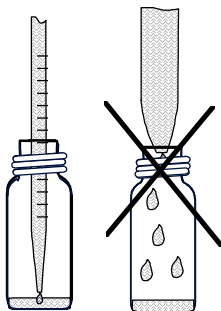

- Cap the AutoSampler vials quickly. If solids were placed in the vial, prior to adding the liquid, mixing with a vortex mixer will assure a homogeneous sample. Aqueous standards and samples remaining in the storage containers that were used to fill the AutoSampler vials, should not be used again.

Just before analysis:

One or two blanks should be run. The AutoSampler vials containing the samples should be allowed to reach room temperature before sampling.

Section 13

Maintenance/Troubleshooting

Routine and preventative maintenance procedures are described in this section. When followed, they ensure optimum performance of the 8200 CX AutoSampler. Varian does not recommend a specific schedule for these maintenance procedures. Rather, you should determine your own regular maintenance schedule for the AutoSampler that reflects the frequency and duration with which the AutoSampler is used. Pages 152 through 155 describe specific maintenance operations which may be performed by the user. Refer to the following diagram.

NOTE: Lubricate or clean only those parts referred to in this Maintenance/Troubleshooting section.

- A Syringe Plunger Lead Screw
- B Belt Tensioner/Pulley
- C Syringe Carriage Stop Latch Solenoid
- D To Position #4 on J8
- E Syringe Carriage Drive Belt
- F To Position #7 on J8
- G Syringe Carriage Drive Motor
- H Syringe Carriage

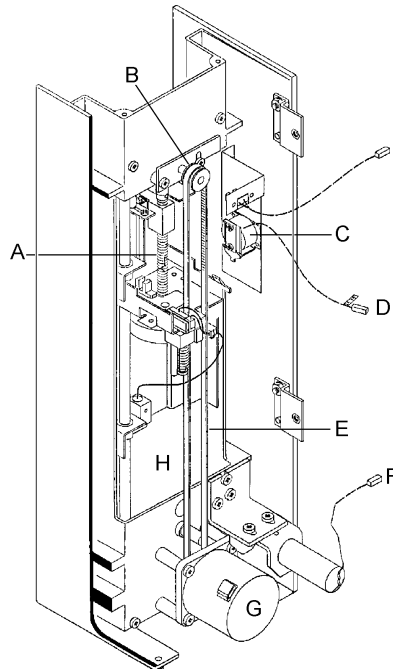

SYRINGE CARRIAGE GUIDE RODS

The guide rods and syringe carriage bushings do not require lubrication. However, you should periodically wipe the guide rods with a clean, lint free cloth dampened with isopropanol. How often the syringe carriage guide rods need cleaning is determined by the cleanliness of the environment in which the 8200 CX AutoSampler is used.

SYRINGE CARRIAGE DRIVE BELT

The drive belt is adjusted at the factory and does not usually require adjustment. If you need to adjust or replace the drive belt, proceed as follows:



**WARNING:
SHOCK HAZARD**

**Dangerous Voltages Exposed When High Voltage Cover is removed.
Unplug Power Cord.**

1. Turn off the power to the AutoSampler and disconnect the power cord. The power switch is located on the rear of the tower.
2. Remove the module cover by removing four screws: the two screws on the top of the cover and the two screws at the lower rear panel.

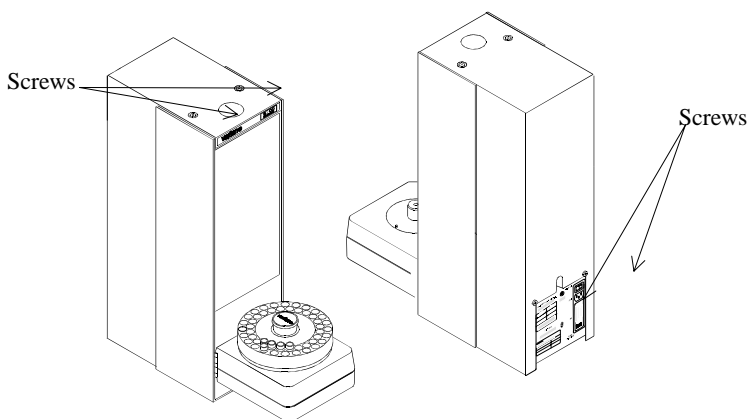

3. Remove the four screws at the module connecting brackets.
 - Disconnect the flat cable connector from J9 on the Controller PC Board and position #4 connector of J8. See the following diagram.
 - Separate the injection tower module and the pneumatics module.

4. Locate the belt tensioner bracket and mounting screws. Loosen the bracket mounting screws.
 - Adjust the bracket to increase/decrease the tension on the belt. There should be just enough tension to prevent slippage of timing belt teeth on the motor drive timing belt sprocket.
 - Tighten the tensioner bracket screws.
5. Reconnect the position #4 connector of J8, and connect the flat cable connector to J9.
 - Replace the tie wrap on the connectors if removed. Reassemble the modules and tighten all screws.
6. Reconnect the power cord.

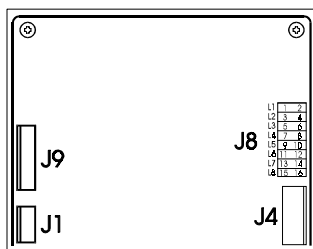

SOLVENT COMPATIBILITY

The materials in the 8200 CX AutoSampler that contact solvents are passivated 316 stainless steel, inert polymers and fluoropolymers. Any solvents used with the 8200 CX AutoSampler must be compatible with these materials.

Avoid the following solvents:

- Halide- (F, Cl, BR, I) containing buffers or acids at concentrations exceeding 2M or having pHs of less than 2.
- Solvents that can form HCl, such as carbon tetrachloride or chloroform.
- Freon 11, TF, or FC-72.

SYRINGE AND SYRINGE NEEDLE MAINTENANCE

SYRINGE CARE

Acetone is recommended as a cleaning solvent when cleaning the syringe. Do not immerse the syringe in the solvent. The adhesive used to bond the metal flange and front needle fittings to the glass barrel will be damaged by soaking in a solvent. Clean only the outside surfaces of the syringe by wiping with a cleaning material.

Thoroughly rinse with acetone and dry before storing the syringe.

Varian syringes have been designed to withstand temperatures to 120°C. Rapid changes in temperature, however, may cause the glass barrel to split.

NEEDLE CARE AND REPLACEMENT

Needles are checked for correct flow before shipping. If your needle does become blocked during usage, remove it from the barrel and gently push solvent through it in the reverse direction.

Check the needle tip for burrs that can damage septa material, causing septa material to deposit in the chromatographic system.

If you need to replace the syringe needle, you will need

- Replacement needle (P/N 03-918987-00)
1. Remove the syringe/needle assembly from the syringe mounting bracket.
 2. Unscrew the syringe nut and remove the needle assembly.
 3. Remove the syringe nut and spring from the old needle; fit them to the new needle as indicated in the diagram.
 4. Introduce the back of the needle into the syringe barrel. Push in on and tighten the syringe nut with your fingers.
 5. Snap the syringe/needle assembly into the syringe mounting bracket. Check that the needle is properly positioned over the injector port.

REPLACING THE MAIN POWER FUSE

To perform this operation, you will need a **narrow blade screwdriver**.

To replace the main power fuse, proceed as follows:

1. Open the fuse block/cover assembly with a narrow blade screwdriver.
2. Snap out the defective fuse and replace with a fuse of the same voltage and amperage.

NOTE: One 0.5 Amp SB fuse will be exposed for 100/120V. Two 0.2 Amp T-Type fuses will be exposed for 220/240V.

Fusing Arrangement (220/240V)

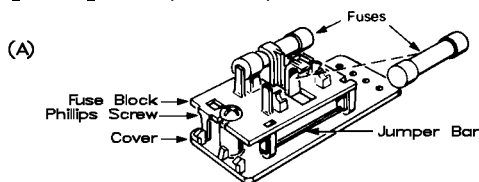

Fusing Arrangement (100/120V)

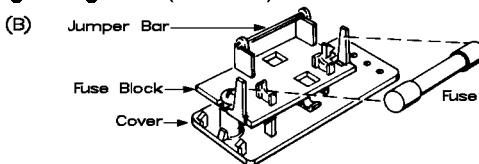

INSTRUMENT TROUBLESHOOTING

Refer to Table 11-1 for descriptions of possible chromatographic and hardware problems, their causes, and the actions you should take to correct them.

NOTE: Before troubleshooting a problem with your 8200 CX AutoSampler, make one or more manual injections first to establish that the problem is in fact a problem with the AutoSampler. Often, the source of the problem is misdiagnosed as a problem with the AutoSampler when the problem is actually with the gas chromatograph (leaks, poor column/injector connections, adsorption within the injector).

Table 11-1 Troubleshooting

Observed Problem	Possible Cause	Corrective Action
Split peaks	Injection speed too slow for split injection	Use a fast injection speed (5 to 10 $\mu\text{L}/\text{sec}$) for split injection to obtain best peak shape, especially for early eluting peaks.
	Injection speed too fast for solvent/column combination	Narrow bore capillary columns easily produce split peaks due to solvent flooding. Reduce injection speed and raise initial column temperature to vaporize solvent gradually during cold on-column or splitless injection.
	Polar sample solvent beads up on non-polar or semi-polar liquid phase	Use a non-polar solvent plug with polar sample solvents to act as co-solvent.
	Sample size too large	Can also cause solvent flooding with narrow bore columns. Reduce sample size if possible; reduce injection speed. Reducing solvent plug size may also help, but may lead to increased solute discrimination.
	Component concentration too high	Exceeding the capacity of the column liquid phase (overloading the column) may cause split or deformed peaks. Reduce the sample concentration by diluting the sample.
Poor peak area reproducibility (High Area RSDs)	Syringe leaking at needle seal (solvent appears around syringe nut)	Check that the syringe nut is tight; if leaks continue, replace needle and Kalrez [®] seal. When replacing needle, check syringe barrel surface for cracks or chips. If you notice cracks or large chips, replace the syringe.
	Syringe leaking at plunger seal (solvent appears on upper body of syringe)	Leaks at plunger seal lead to solvent flowing over outside of syringe barrel during wash cycle. Tighten plunger guide to restore seal. Do not overtighten; increased friction causes stepper motor to stall.
	Syringe plunger tip Teflon [®] seal worn	Replace syringe. A worn Teflon plunger tip seal allows air or solvent to flow past the plunger tip, causing inconsistent sample sizes to be withdrawn from vial.
	Viscous sample injected with wrong mode	Use Viscous Sample Mode, instead of Standard Mode.
	Volatile sample injected with wrong mode	Use Volatile Sample Mode instead of Standard Sample Mode when injecting solvents such as methylene chloride, carbon disulfide, or pentane.

Observed Problem	Possible Cause	Corrective Action
	Partially plugged needle	Replace needle if you cannot clear the plug.
	Inlet problems	Check for leaks, flow controller failures, pressure fluctuations, etc. See Troubleshooting section of your GC Operator's Manual.
	Waste arm plugged	Check for free flow of wash solvent through syringe and out waste arm.
	Solvent reservoir empty	Refill reservoir.
	Too many injections per vial	With long run times and volatile sample solvents, concentration of components in sample increases after sample vial septum is punctured. When using Neat Mode, a slight vacuum forms within vial as sample is withdrawn.
	Insufficient solvent plug volume when using solvent flush injection	Solvent plug volume must be greater than needle volume; i.e., 1.0 μ L or more.
Bent needle	Tray misaligned	If syringe is installed correctly in syringe holder (vertical, with no binding), and needle hits edge of vial, call Varian Customer Support. Do <i>not</i> rotate the carousel to achieve proper alignment!
	Wrong needle insertion depth	With certain disposable vials and some microvials, a needle depth default of 90% allows needle to hit bottom of vial. Change needle depth to lower value (e.g., 80%).
	Wrong vial used	Use only 1.5 mL vials and microvials certified acceptable by Varian. In particular, some microvial inserts have very small openings, allowing the AutoSampler needle to hit the glass edge.
	Syringe misaligned	Adjust the syringe mount, following the procedure in described in this Operator's Manual.
	Needle hits edge of septum nut when injecting	If syringe is mounted correctly in syringe holder (vertical, with no binding, aligned with sample vials), then loosen the AutoSampler mounting plate screw and align the AutoSampler with injector, as described in this Operator's Manual.

Observed Problem	Possible Cause	Corrective Action
	Too much resistance from new septum	After a new septum is installed, lower the AutoSampler carriage by hand until the needle pierces the new septum. This procedure also checks the alignment of the needle with the injection port. Do not overtighten the injector nut, as this increases the force required for the needle to penetrate the septum.
	Obstruction within injector	Check for obstructions or for incorrect column installation in injector. In particular, make sure that small diameter columns are not being used with large diameter inserts in the SPI. The wrong insert allows columns to be inserted too far into the injector.
Sample component carryover (“ghost peaks”)	Wash time too short	Use longer wash time (default of 20 seconds).
	Wrong wash solvent	Use a wash solvent that is miscible with sample solvent. If the sample is composed of constituents with a wide range of polarities, especially in high concentrations (e.g., perfumes), use two wash solvents of different polarities.
	Defective syringe and/or needle	Voids or gaps in syringe seals or dead volume in tip of defective needle leads to carryover; replace syringe and/or needle.
	Inlet problem	Inlet may be too cold, poor seals may produce poorly swept areas, or otherwise contribute to carryover. Consult Troubleshooting Section of your GC Operator’s Manual.
	Plugged wash bottle filter	Replace filter. Verify that wash solvent flows freely through syringe during wash cycle.
	Valves plugged due to swollen Viton® seals caused by using ketones as wash solvent	If necessary to use ketones as wash solvents, replace standard valves with optional valves built with Kalrez seals (P/N 03-918533-90).
	Waste arm plugged	Clear waste arm; ensure free flow of solvent through syringe during wash cycle.
	Wash solvent reservoir empty	Refill reservoir.

Observed Problem	Possible Cause	Corrective Action
	Contaminated gas supply to the AutoSampler	Not actually sample component carryover, but extra peaks due to contaminants dissolved in wash and backup solvent. Check that the gas supply to the AutoSampler is chromatographically pure. At minimum, direct gas supply through a good hydrocarbon/organics filter.
	Contaminated wash solvent	Use only chromatographic grade wash and backup solvents.
	Septum contamination	Condition injector septa in GC oven prior to use. For ultratrace analysis, condition waste arm septa also.
Wash solvent carryover	Wrong sampling mode chosen	If wash solvent carryover is not desired, use the Neat Sampling Mode.
	Wash solvent too viscous to be removed by Neat Sampling Mode	Use a less viscous wash solvent; or use the original wash solvent followed by a less viscous solvent; or use air dry in User Defined Mode to remove most solvent before sampling.
	Wash bottle filter and lines not purged properly when changing to new solvent	When changing solvent in a wash bottle, use a new, dry filter frit. The porous frits absorb a large quantity of solvent, which is difficult to remove completely by purging. After changing solvents, set wash time to 180 sec and repeat several wash cycles.
No peaks, or small peaks	Plugged syringe needle	If you cannot clear the syringe needle, replace needle.
	Bad syringe needle seal	A poor needle seal allows air to be sucked into syringe instead of sample. Replace needle and seal; ensure syringe nut is tight.
	Syringe needle not inserted into sample	Increase value of Vial Needle Depth so that syringe needle dips into the sample. Carefully adjust the Vial Needle Depth when sampling volumes of 20 μ L or less.
	Teflon® plunger seal worn or defective	Sample may be withdrawn into syringe, but leaks past defective Teflon seal when needle is inserted into pressurized injector. Replace syringe.
	GC problems	Wrong splitter setting, leaks, wrong detector settings, broken column, etc. Consult Troubleshooting Section of your GC Operator's Manual.
Short Syringe	High friction due to use of air dry	Use air dry only if absolutely necessary.

Observed Problem	Possible Cause	Corrective Action
Lifetime		
	Overuse of Neat Sampling Mode	Use the Neat Sampling Mode only when you need to minimize the wash solvent carryover. Syringe wear is increased when using this mode.
Syringe needle pulled vial out of tray	Vial retainer arm misaligned	Realign retainer arm or call Varian Customer Support.
	Unapproved vial in carousel	Use only vials approved for use in the 8200 CX AutoSampler.
Vial not found or skipped	Cap of vial removed or missing	Infrared sensor beam must be blocked to detect vial. If vial must be sampled without cap, place opaque tape over the bottom of the vial.
	Defective infrared Sensor	Call Varian Support.
Solvent or sample peak tailing	Injection speed too fast for splitless or large bore (0.53 mm) vaporizing injection	Use slow injection speed (1-2 $\mu\text{L}/\text{sec}$), especially with large sample volumes.
	Inlet or other GC problems	Poor internal seals, plugged septum purge, too low a vent flow, etc., contributes to tailing. Consult Troubleshooting Section of your GC Operator's Manual.
Poor retention time reproducibility	Rarely due to AutoSampler malfunction	Often an inlet system problem. Change injector septum first. If problem persists, consult Troubleshooting Section of your GC Operator's Manual and check entire system for leaks. If you suspect an AutoSampler timing problem, call Varian Customer Support.
Sample discrimination (early or late eluting peaks reduced in size relative to other components)	8200 CX AutoSampler not set to Solvent Flush Mode	Standard Mode, which uses solvent flush injection, should be used to minimize sample discrimination. Do not change the default parameters.
	Injection speed too high	Too high an injection speed into a hot injector results in flashback and the loss of low boiling components. Reduce the AutoSampler injection speed.
	Wrong choice of backup solvent	Low boiling solvents vaporize too rapidly from the syringe needle, leaving higher boiling components behind, especially with slow injection speeds.

Observed Problem	Possible Cause	Corrective Action
	Wrong injector temperature	Too high an injector temperature can cause low-boiling solutes to be lost. Too low an injector temperature can cause high boiling components to be lost in a vaporizing injector. Ideal results are obtained with non-vaporizing injection (SPI), followed by temperature programming of the injector.

Section 14

8200 CX AutoSampler with the Saturn GC/MS

INSTALLATION

Section 2 of this manual describes installation of the AutoSampler. Follow the instructions for Varian GC's. Note the following instructions for the Saturn GC/MS.

1. The PC should have the Saturn software installed (in the factory or by the user) *prior* to installing the 8200 software. Your Saturn GC/MS Workstation software should be version 5.0 or later. A PC with at least two serial ports is required.
2. Since Saturn uses COM 1 to control the GC, connect the 8200 serial cable to COM 2, 3 or 4—not COM 1.

OPERATION

Read Sections 3 through 11 of this manual for instructions on setting up the AutoSampler and building methods and sample lists for Liquid, SPME, Ambient Headspace Injection, and Automated Large Volume Injection. Remember to set the COM port correctly (COM 2 or greater).

NOTE: For details on Saturn operation, consult the Saturn GC/MS manual.

To begin a PC-controlled 8200, Saturn sequence, proceed as follows:

1. In Windows, open the “Varian Star 8200 Control” program group and click on the “Saturn” icon to open the Saturn software. Do not use previously installed icons to open the Saturn software.

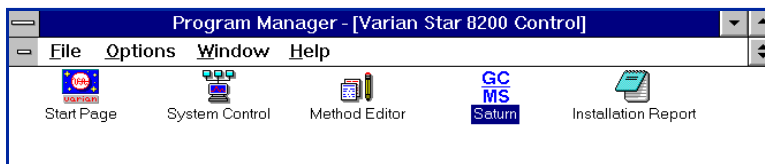

- Go to the “Analysis page” and build a sample list entering the appropriate GC and MS methods for your sample. Leave the column blank where an AutoSampler method would be entered. Any entry under “sampling device” is ignored.

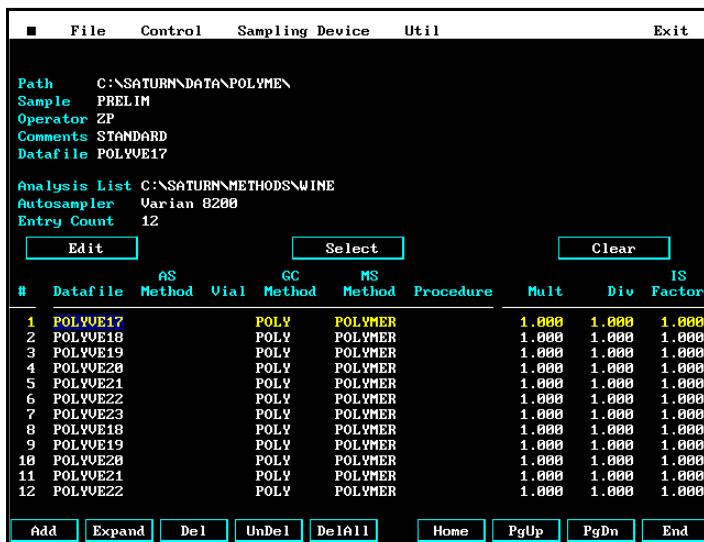

- If you will be using SPME, determine the GC cycle time by allowing the GC to go through at least one complete run, including cool-down and re-equilibration. This step may be omitted if you will be doing liquid or ambient headspace injection.
- Press the **Alt + Tab** keys on your PC to switch to the Program Manager in Windows.
- Open “System Control” and build an AutoSampler method, sample list and sequence as described earlier in this manual. For SPME methods, enter the GC cycle time as determined in step 3.
- Activate the Sequence to begin sampling.
- Press the **Alt + Tab** keys on your PC to switch to the Saturn “Analysis” page.
- Pull down the “Control” menu and select “Start autosampler run”.

OPERATION NOTES

Refer to the Saturn GC/MS manual and Software Release Notes for guidelines regarding PC selection and configuring the software. It is recommended that the user disable screen savers and log out of networks before running a PC-controlled 8200-Saturn sequence.

During the installation, a “SATURN.PIF” file is created. This should not be altered, unless the locations of the Saturn software is not C:\SATURN.

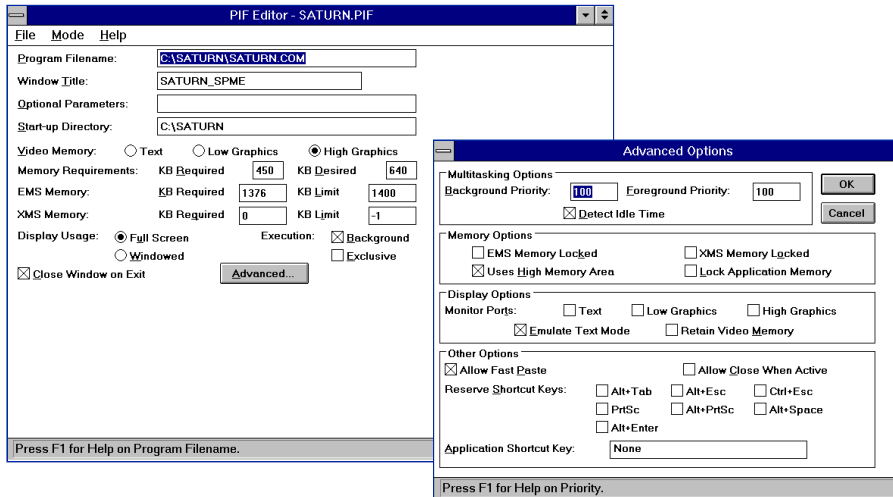

In this case, you will need to modify SATURN.PIF to substitute the appropriate path to C:\SATURN in both the Filename and the Start-up Directory field. Use the program named PIFEDIT.EXE to modify SATURN.PIF.

Section 15

8200 CX Parts and Supplies

Description	Part Number
Serial Cable (8200 to PC)	03-918965-00
Interface Cable (8200 to 3400/3600)	03-918966-00
Interface Cable (8200 to HP 5890)	03-918871-00
HP Top Cover Kit	03-918861-90
SPME Test Sample	03-918967-00
12-Vial Carrousel	03-918870-00
Labels for 12-vial Carrousel	03-925270-00
Labels for 48-vial Carrousel	03-925271-00
10 mL Cap: Vials (pk/36)	03-918873-01
10 mL Cap with Septum (pk/36)	03-918875-01
O-ring for 10 mL Vial (pk/36)	03-918874-01
10 mL capacity Vials (pk of 288)	03-918873-02
10 mL cap with Septum (pk of 288)	03-918875-02
O-ring for 10 mL Vial (pk of 288)	03-918874-02

Large Volume Injection	
100 μ L Syringe with Needle	03-925414-01
100 μ L Syringe Needle	03-908824-00
2 mm 1078 insert packed with deactivated glass wool	03-925350-00
3.4 mm 1078 insert packed with 10% OV-101 on Chromosorb W-HP 80/100	03-918956-00
0.5 mm 1078 open insert	03-925331-00

Ambient Headspace	
8200 CX Syringe, 100 μ L w/sidearm	03-918728-00
100 μ L Syringe Needle	03-908824-00

SPME FIBERS (3 FIBERS PER PACKAGE)***Polydimethylsiloxane***100 μm coating for volatiles (280°C inlet, red hub)

Description	Part Number
For manual sampling	03-918963-01
For 8100/8200 AutoSamplers	03-918963-02

30 μm coating for semivolatiles and pesticides (280°C inlet, yellow hub)

For manual sampling	03-918963-09
For 8100/8200 AutoSamplers	03-918963-10

7 μm coating for mid to nonpolar semivolatiles (320°C inlet, green hub)

For manual sampling	03-918963-04
For 8100/8200 AutoSamplers	03-918963-03

Polyacrylate85 μm coating for semivolatiles (310°C inlet, white hub)

For manual sampling	03-918963-05
For 8100/8200 AutoSamplers	03-918963-06

Carbowax/Divinylbenzene65 μm coating for alcohols and polar compounds (265°C inlet, orange hub)

For manual sampling	03-918963-11
For 8100/8200 AutoSamplers	03-918963-12

Assortment PackOne fiber of each type (100 μm PDMS, 7 μm PDMS, 85 μm Polyacrylate)

For manual sampling	03-918963-07
For 8100/8200 AutoSamplers	03-918963-08

SPME Holders

For manual sampling	03-918964-01
For 8100/8200 AutoSamplers	03-918964-02

Index

.mth extension..... 69, 80, 107, 127
100 µL Headspace Syringe 103
100 µL Syringe 106
100-µL headspace syringe 103
12-Vial Carrousel 5, 7, 8, 77, 85, 88, 167
48-Vial Carrousel 5, 7, 8, 74, 87, 113, 167
8200 CX AutoSampler
 Features 5

—A—

Absorb Time 80
Activate a Method 125
Activate Method 135
Activator Strip 95, 101
Active SampleList..... 130, 131, 134
Active Sequence 137, 138, 139
Adapter 23
Adjust Vial Retainer Arm..... 84
Agitate Box..... 96
Agitation Device 94
Agitator Septum..... 97
Air Drying..... 65
Align Syringe Needle..... 53
Ambient Headspace Injection 5, 6, 14, 16,
 103, 108, 109, 112, 164
Ambient Headspace Injection Operation 113
Analysis 131
Application Notes 143
AutoControl Module 37, 39
AutoLink..... 135
Automix 140
Automix Routines..... 140
AutoSampler Timing 62, 160

—B—

Ball Plunger Screws..... 31
Baseline 131
Build a
 Headspace Injection Method..... 103
 SPME Injection Method 77, 82
Build a SPME Injection Method 77
Build the
 Headspace Injection Method..... 103
Build the Liquid Injection Method 60

Building a
 Liquid Injection Method 60

—C—

Calibration 131
Captive Screws..... 31
Carrousel 5, 7
 12 Vial..... 79
 48 Vial..... 79, 105
 Loading 71, 87, 113
Carrousel Label..... 8, 9, 71, 87
Carrousel Type
 12 Vial..... 62
 48 Vial..... 62
Carrouseles 8
COM Address 23, 37, 38, 61, 78, 105, 163
Configuration Files 41, 42
Configuration Window 36-38, 39, 42, 61, 62,
 69, 77, 79, 105, 125

—D—

Default Settings..... 133
Delete SampleList Entries 134
Desorb Time..... 80, 90
Diffusion Rate..... 93
Downloading a Method..... 134

—E—

EndTime..... 62
Equilibrium..... 93

—F—

Features..... 146
Fiber Holder..... 16, 77, 80
Fuse..... 7, 17, 32

—G—

Gas Inlet..... 54, 108

—H—

Hardware Configuration	39, 42, 60, 77
Headspace Sampling	89, 143
Hot Needle Time	16, 68, 106
HP 5890	
Gas Chromatographs	44
HP 5890 GC	5, 41, 49, 50, 167
Mounting Hardware	44
Remove Injector	44
Remove Top Covers	44

—I—

Injection Methods	6
Injection Rate	68, 106
Injection Tower Module	7, 11, 152
Injector Insert	82, 85, 145
injector spacer	45
Injector Temperature	89, 148, 161
Installation	17
Installation Check	43
Instrument Parameters	38, 128
IRQ Setting	38

—L—

Large Volume Injection (LVI)	115
Leaks	72, 155
Liquid Injection	6, 12, 16, 43
Liquid Injection Method	60
Liquid Injection Operation	71
Liquid Injection Setup	53
Liquid Sampling	16, 41, 89, 106, 145
Lower Air Gap	64, 67, 73

—M—

Maintenance	151
MANUALn.SEQ	129
MANUALn.SMP	129
Max Errors	39, 128
Method Editor	60, 69, 77, 78, 80, 104, 105
Method File	60, 69, 78
Microvials	15, 16, 66, 75, 157
Mounting Hardware	11, 17, 20, 26, 43
Mounting Plates	17, 21, 31, 43, 83, 111

—N—

Neat	5, 6, 16, 62, 63, 65, 157, 160
Needle Residence Time	65, 68
New Method Section	61, 78, 104

—P—

Parts and Supplies	167
Pause Time	63, 67, 106
Performing Injections	125
Pneumatics Module	5, 7, 9, 10, 11, 55, 152
Position Sensor Board	7
Power Switch	7, 9, 22, 24, 32, 36, 49, 58, 82, 111, 125, 152
Pre-drilled Septum	96
Prep Ahead	62, 80, 105
Pressure Regulator	9, 54, 108

—S—

Sample Vials	74, 87, 88, 113, 157
SampleList	129-131, 134, 136-138, 142
Sampling Modes	62, 79, 105
Saturn	23, 34, 41, 163, 165
Saturn GC/MS Workstation software	163
SATURN.PIF	165
Semi-volatile Components	93
Septum	13, 59, 66, 71, 73, 74, 81, 84, 87, 109, 112, 113, 145, 147, 157, 159, 160, 167
Sequence	129, 137, 138, 139, 164
Serial Board	26
Serial Cable	51
Solvent Flush Sampling	63, 65, 67, 106
Solvent Plug Size	73, 156
Solvent Plug Size	66
Solvent Reservoir Bracket	53, 54, 69
Solvent Reservoirs	9, 71, 109
Solvents	5, 6, 63, 71, 143, 153, 156, 158, 160
Specifications	15, 16
SPME Fibers	168
SPME Holder	13, 81, 82, 168
SPME III Agitation	93
SPME Injection	6, 13, 16, 17, 23, 43, 51, 77, 82
SPME Injection Method	77, 80, 82, 85, 87
SPME Injection Operation	87
Standard	16, 62, 63
Standard Accessory Kit	14
Standard Mode	15, 72, 156
Standard Solvent Flush	6

-
- Star Chromatography
 Workstation..... 5, 34, 35, 39, 77, 129, 137
STARTUPn.MTH..... 138
Status Cable 22, 24, 26, 30, 43, 49, 50,
 51, 61, 78, 105
Storage Module 5, 7, 11, 15, 18, 20, 30, 84, 111
Storage Module Latch Release 58, 83, 111
Syringe Carriage 11, 14, 19, 56, 59, 73,
 77, 80, 83, 85, 110, 111
 Drive Belt..... 152
 Guide Rods 152
Syringe Carriage Bracket..... 57
Syringe Carriage Stop Solenoid..... 58
Syringe/Needle Assembly... 12, 53, 56, 69, 110, 154
System Control Configuration 36, 37, 39,
 125, 130, 137
System Description..... 6
- T—
- Test Sample 89, 167
Top Covers 6, 20
 Varian 47
Troubleshooting..... 151
Turntable 7, 8, 9, 87
- U—
- Upper Air Gap..... 63, 67, 73
Uptake Rate..... 93
Uptake Speed 16, 63, 65, 67, 106
User-Defined Mode 6, 62
- V—
- Venting 72
Verification 131
Vial Needle Depth 66, 106, 159
Vial Retainer Alignment 34
Vial Retainer Arm..... 14, 77, 85, 160
 Adjust 84
Vial Sensors 7
Vial Septa..... 74, 88, 113
Viscous 5, 6, 16, 62, 64, 67, 143, 156
Volatile 5, 6, 16, 62, 63, 143, 156
Volatile Solvents..... 72
Voltage Selector Card..... 32
- W—
- Wash Cycle 15, 65, 74, 156, 159
Waste Arm 14, 64, 73, 157